

This document reproduces the complete and unabridged text of a United States Army Field Manual first published by the Department of the Army, Washington DC.

All source material contained in the reproduced document has been approved for public release and unlimited distribution by an agency of the US Government. Any US Government markings in this reproduction that indicate limited distribution or classified material have been superseded by downgrading instructions that were promulgated by an agency of the US government after the original publication of the document.

No US government agency is associated with the publishing of this reproduction.

Digital viewer interface reformatting, viewer interface bookmarks and viewer interface links were revised, edited, ammended, and or provided for this edition by I.L. Holdridge.

This page and the viewer interface reformatting  
© I.L. Holdridge 1999.  
All rights reserved.

# The Signal Leader's Guide

## Contents

	Page
<b>Preface</b>	iii
<b>Introduction</b>	v
<b>Chapter 1 Signal Support</b>	1-1
Section I. Signal Support Disciplines	1-1
Section II. Signal Responsibilities	1-11
<b>Chapter 2 Signal Support and Organization</b>	2-1
Section I. Supporting the Corps and Division	2-1
Section II. Supporting the Maneuver Brigade/Battalion	2-9

**Unless this publication states otherwise, masculine nouns and pronouns do not refer exclusively to men.**

**Distribution Restriction: Approved for public release; distribution is unlimited.**

	<b>Page</b>
<b>Chapter 3 Area Communications Systems</b>	3-1
<b>Chapter 4 Combat Net Radio</b>	4-1
<b>Chapter 5 Basic Signal Leader Information</b>	5-1
Section I. Profiling Radio Links	5-1
Section II. Conducting Convoy Operation	5-3
Section III. Signal Site Selection/Set Up	5-10
Section IV. Signal Site Security	5-12
Section V. Communications Under Special Conditions	5-16
Section VI. Power Generation Sources	5-22
<b>Appendix A Communications Planning Guide</b>	A-1
<b>Appendix B MSE Distribution</b>	B-1
<b>Appendix C Priorities of Work Chart</b>	C-1
<b>Appendix D Risk Assessment Chart</b>	D-1
<b>Glossary</b>	Glossary-1
<b>References</b>	References- 1
<b>Index</b>	Index-1

# Preface

## Purpose and Scope

This manual is a hip pocket-sized field reference guide for junior signal leaders (officers and noncommissioned officers (NCOs)). It is intended to help the signal leader to understand and to implement signal support under the Information Mission Area (IMA) concept.

This manual covers commonly needed information such as signal site reconnaissance, leading convoys, profiling line-of-sight (LOS) links, and troubleshooting signal equipment. It also contains an overview of signal support doctrine and currently fielded communications systems. It is targeted at junior signal officers and NCOs in tactical environments from battalion through echelons above corps (EAC).

## The Principles of Leadership

- Know yourself and seek self-improvement.
- Be technically and tactically proficient.
- Seek and accept responsibility for your actions.
- Make sound and timely decisions.
- Set an example.
- Know your soldiers and look out for their well-being.
- Keep your subordinates and superiors informed.
- Develop a sense of responsibility in your subordinates.
- Ensure the task is understood, supervised, and accomplished to standard.

## **FM 11-43**

- Build a team.
- Employ your unit according to its capabilities

**FM 22-100, *Military Leadership*, covers this subject in detail.**

## **Troop-Leading Procedures**

- Receive the mission.
- Issue warning order.
- Make tentative plan.
- Start necessary movement.
- Conduct reconnaissance.
- Complete the plan.
- Issue the order.
- Supervise.

**FM 71-123, *Tactics and Techniques for Combined Arms Heavy Forces: Armored Brigade, Battalion/Task Force, and Company Team*, covers this subject in detail.**

## **User Information**

The proponent of this publication is the United States Army Signal Center. Send comments and recommendations on DA Form 2028 directly to Commander, United States Army Signal Center and Fort Gordon, ATTN: ATZH-DTL, Fort Gordon, Georgia 30905-5075. Key comments and recommendations to pages and lines of text to which they apply. If DA Form 2028 is not available, a letter is acceptable. Provide reasons for your comments to ensure understanding and proper evaluation.

## Introduction

Successfully supporting the commander with reliable and redundant communications is a direct result of **detailed planning**. Planning signal support operations should not occur in a vacuum or just among signalers. For communications to successfully support the commander, several steps must occur with absolute conviction. The most critical step in understanding what is expected from a signal leader and planner is understanding the commander's intent. From the commander's intent, all planning can begin among sections, staffs, units and individuals. The staff planning process per the Command and General Staff College (CGSC) Student Text (ST) 101-5 and the wargaming process begin immediately. Warning orders and fragmentary orders (FRAGOs) can be issued to subordinates so they can make maximum use of the time available and execute the appropriate troop-leading procedures.

**Soldiers' lives** hinge on our ability to plan tactical operations. Planners must successfully synchronize and integrate the plan to support the commander. Communications must support the scheme of maneuver as every other battlefield functional area (BFA) must in a synchronized and integrated effort put maximum focus on a specific objective at a specific time. This will ensure the commander accomplishes the mission. Today's battlefield is three dimensional and signal planning must be done with

## FM 11-43

the same application of thought. Planning and coordinating joint operations or operations other than war (OOTW) also must be done with great detail and forethought. Soldiers and signal teams deserve the opportunity to survive based on solid plans and viable contingencies to support unstable situations.

Soldiers must understand several issues for success in a tactical environment. Leaders must keep soldiers informed and updated on all key information. The first issue is an understanding that **a communications problem is everyone's concern until it is solved**. The second issue involves signal soldiers who are highly qualified representatives of the Signal Corps and as such we are all trainers. This means when a user has a communications problem we try our best to educate them so they become **self-reliant**. If we fail to educate, then we must not only do our own work, but we must also do someone else's work. Next, we must train as if we are going to war/conflict. This means we cannot accept the training standard that communications assets go unescorted into the maneuver boxes/threat areas days in advance just to ensure communications are ready. Once in a tactical situation, specific channels for accurate and timely intelligence, battle tracking, and environmental and situational awareness must be developed. This information must be disseminated to the lowest levels possible. All node centers (NCs), radio access units (RAUs), retransmission (RETRANS), and relay teams must get this information promptly. The information

ensures the teams understand and can support the maneuver schemes and are synchronized with other BFAs across the battlefield. Awareness of the enemy or threat enables the soldier to feel secure in their surroundings.

As a signal leader, you are tasked with great responsibility. Plan for success and win the information war.



# Chapter 1

## Signal Support

### Section I.

#### Signal Support Disciplines

#### 1-1. Information Mission Area (IMA)

Under the IMA concept, signal support provides the commander the means to command and control (C<sup>2</sup>) on the battlefield. The IMA doctrine covers all aspects of information management. It consists of five disciplines:

- Communications.
- Automation.
- Visual Information (VI).
- Records Management.
- Printing and Publications.

The signal support responsibilities to each of these disciplines differ at the tactical, operational, and strategic levels of war. All signal personnel must understand the IMA disciplines and the need for signal support.

*FM 11-75 covers this subject in more detail.*

### 1-2. Communications

Tactical communications transfers information throughout the battlefield. Information is generally divided into three categories:

**Voice.** Voice traffic provides real time user-to-user information flow.

- User-to-user — Interactive two-way traffic.
- Conference — Several parties conversing together.
- Broadcast — One-way area coverage.

**Message.** This is hard-copy information such as documents, charts, maps, and photographs. Message traffic generally falls into two classifications:

- Formal — Passed through the record traffic system.
- Informal — Passed directly between users.

**Data.** This is digital information passed from machine to machine. When computers are linked together to pass information or share resources, the result is a computer network.

User units are responsible for installing, operating, and maintaining all user-owned signal equipment. This includes coordinating with the signal officer for equipment training. The unit staff should address all communications matters to the staff signal officer.

Signal support provides the above services in one of two ways, depending on user requests.

**Common user.** All users of a communications system have access to a large group of subscribers with minimum communications assets.

**Sole user.** This service provides a link between two points where high priority or high-volume traffic prevents sharing common-user links. Sole-user service is no longer used at tactical levels of the Army. Support of joint organizations requires the occasional use of sole-user circuits over satellite systems.

Tactical communications architecture is generally divided into the following wide area networks (WANs):

- Area Common-User System (ACUS).
- Combat Net Radio (CNR) System.
- Army Data Distribution System (ADDS).
- Broadcast Communications System.

**ACUS.** It is a communications system made up of a series of network node switching centers connected primarily by line-of-sight (LOS) multichannel radios and tactical satellites (TACSAT). Army ACUS networks are Tri-Service Tactical Communications (TRI-TAC) at echelons above corps (EAC) and mobile subscriber equipment (MSE) at echelons corps and below (ECB). ACUS provides a multiuser, common-user area system for high-volume voice and data communications. Users at or near extension nodes link to the system for access to other users.

## **FM 11-43**

**CNR.** They are single-channel and frequency hopping (FH) radios which are organic to almost all organizations. CNRs are the primary means of communications in maneuver units. To support the commander, units use these radios in networks such as command, administrative logistical, and intelligence/operations. An example is the Single-Channel Ground and Airborne Radio System (SINCGARS).

**ADDS.** It is an integrated C<sup>2</sup> communications system providing near real-time transmission capabilities to support low- to medium-volume data networks. The system automatically relays information from the origin to the destination transparent to the user.

Subsystems are the Joint Tactical Information Distribution System (JTIDS) and the Enhanced Position Location Reporting System (EPLRS).

**Broadcast.** Communications systems use technology similar to commercial radio stations. Transmit-only stations send information to high frequency (HF) radio systems, satellites, unmanned aerial vehicles (UAVs), or other means. Weather, intelligence, and position location/navigation (POS/NAV) information are support derived from the broadcast system.

***FM 11-75 covers this subject in more detail.***

### 1-3. Automation

Automation refers to computer hardware and software used for various purposes across the operational continuum. Units perform maneuver control and operations through Battlefield Automated Systems (BAS). The units also use other kinds of software to aid in managing many unit functions. These automated systems include word processing, financial analysis, maintenance requests, and personnel databases. Because of the widespread use of automated systems, automation covers several issues including, but not limited to—

- Establishing standards and policies for local automated information systems.
- Developing information management requirements.
- Allocating automation devices.
- Installing system and functional software.
- Installing local area networks (LANs).
- Coordinating interface with other networks.
- Establishing standards to ensure software security.
- Backing up and restoring data.
- Conducting operator training.
- Controlling software versions.
- Performing unit-level system maintenance.

The common hardware and software (CHS) program provides computers and supporting applications as building blocks from which interoperable battle command systems are implemented.

### 1-4. Visual Information

VI is the documentation of military operations: processing, transmitting, reproducing, and distributing visual imagery, graphics production, conferencing, and multimedia presentation services within the theater or tactical environment.

VI assets are found at the corps level and above. Signal staff officers below corps must request VI support when needed. Requests are sent to the next higher echelon's signal office. The signal officer then assists the unit commander by directing VI assets to support the assigned mission. This includes—

- Establishing VI policies and procedures.
- Briefing commanders on capabilities/limitations of combat camera (COMCAM) units and procedures for requesting COMCAM support.
- Integrating VI to support battlefield functional information systems at their level of command.

Units must coordinate VI requirements along functional lines to avoid duplicating VI assets in the same mission area. The unit staff must—

- Develop its own VI requirements and standardize VI equipment and systems to Department of Defense (DOD) and COMCAM unit standards.
- Manage organic VI systems.
- Establish VI policies and procedures according to the recommendations of the signal officer.

Tactical VI includes COMCAM and functional VI support.

**COMCAM.** Its mission is to document the activities of all military services. This documentation is used for both operational decision making and historical records. COMCAM units document operations or events regardless of classification or sensitivity. Decisions on classification, sensitivity, or release are made afterward through command, intelligence, operations, and staff coordination. COMCAM imagery requirements include—

- Recording or documenting key actions before, during, and after mobilization, deployment, force generation, and force employment.
- Assessing the effectiveness of force preparations, support operations and objectives, and problem identification.
- Evaluating the effectiveness of weapons systems, intelligence related activities, medical support, public affair purposes, and countering enemy propaganda.
  - Historical documentation.
  - Maintaining stock footage.

At theater and corps, COMCAM support is provided by COMCAM companies. For each division in the corps, support is provided by a COMCAM platoon in the corps' COMCAM company. When tasked, teams from the COMCAM platoon provide support to brigades and battalions.

## FM 11-43

COMCAM teams are task organized. Team size is normally two to four soldiers. Figure 1-1 shows a typical COMCAM support structure. Team size, skill and equipment needs are determined by the mission. All COMCAM units fall under the operational control (OPCON) of their signal officer.

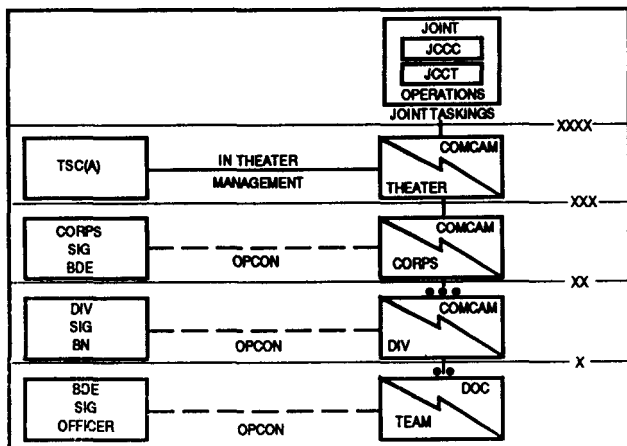

*Figure 1-1. Typical COMCAM support structure.*



**Functional VI Support.** Functional VI is user-owned and user-operated and does not include COMCAM. The primary purpose of functional VI is to support the unique information and decision-making requirements of the specific commander. Examples of functional VI support are the organic activities of military intelligence, psychological operations (PSYOP), public affairs, and medical units.

*FM 24-40 covers VI in more detail.*

## **1-5. Records Management**

Records management is the administration of correspondence, reports, forms, directives, publications, and distribution/official mail. It includes the maintenance of record information, classification/declassification of recorded information, and the implementation of responsibilities under the freedom of information and privacy acts.

**Objectives.** The goals of the records management system are to create the records essential to support, sustain, and document the following:

- Military operations in time of war and operations other than war (OOTW).
- Protect the rights and interests of the Army, its uniformed members, their family members, and civilian employees.
- Distribution/official mail management.
- The Modern Army Recordkeeping System (MARKS) provides procedures for the systematic identification, maintenance, retirement, and destruction of Army information.

## FM 11-43

- Correspondence management limits correspondence to essential requirements. **(See AR 25-50.)**
- The Freedom of Information Act (FOIA) program activities are conducted in an open manner consistent with the need for security and adherence to other requirements of law. **(See AR 25-55.)**
- The Privacy Act (PA) program protects the privacy of an individual from unwarranted invasion by ensuring that collection and maintenance of recorded information about the individual is necessary and accurate. **(See AR 340-21.)**
- Personnel records maintenance during wartime is kept to an absolute minimum. Staffing of records branches will not allow the extensive personal service provided during peacetime.

***FM 11-75 covers this subject in more detail.***

## 1-6. Printing and Publications

Printing and publications are the processes of information composition and representation on media. It covers printing, reproduction, and publications management. There are no organic printing capabilities at corps and below, other than engineer topographic and PSYOP units. Although low-quantity printing requirements can be done with user-owned automated systems connected to printers, large-volume printing and copying requests are performed at theater.

Units with publications accounts order and distribute Army publications to their subordinate units. Although not mandatory, the unit may maintain a publications library

and perform systematic management of publications and reproduction equipment. The systematic management of publications includes initiatives to modernize the Army publications system with new publishing management concepts.

*FM 11-75 covers this subject in more detail.*

## **Section II.**

### **Signal Responsibilities**

The signal officer works for the force commander and is responsible for providing signal support for the following areas: the Army Tactical Command and Control System (ATCCS), Battlefield Information Services (BIS), and Tactical VI Systems.

#### **1-7. Army Tactical Command and Control System**

ATCCS is the integration of the IMA disciplines of communications and automation. All information relating to the battle is divided into seven categories called Battlefield Operating Systems (BOSS) or Battlefield Functional Areas (BFAs). They are—

- Maneuver.
- Fire support.
- Air defense.
- Battle command.
- Intelligence.

## **FM 11-43**

- Mobility and survivability.
- Logistics.

BASs are the functional information systems which support the seven BOSs.

***TRADOC Pamphlet 11-9 covers this subject in more detail.***

These information systems consist of computer hardware and software that organize and manage battlefield information. All systems must be interconnected to successfully pass voice, message, and data traffic to and from the commander, his staff, and higher and lower echelons. Signal support provides the means to interconnect the BOSs. This is done through four tactical communications systems that support the BFAs. They are ACUS, CNR, ADDS, and broadcast. See Figure 1-2.

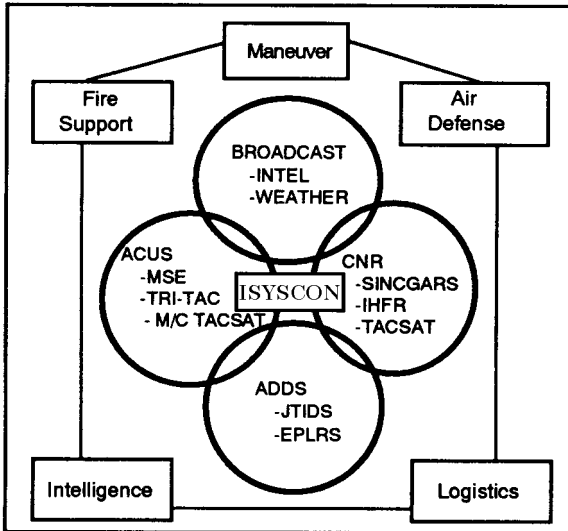

Figure 1-2. The Army communications architecture.

### 1-8. Battlefield Information Services

Two IMA disciplines, records management and printing and publications compose the BIS. BIS are administrative services that are performed on the battlefield. When a maneuver unit deploys, the organic signal element is responsible for BIS. At brigade and battalion, the Information Services Support Officer (ISSO) is the S1. At division and corps, the ISSO is in the assistant division signal office (ADSO)/G6. The Directorate of Information Management (DOIM) is responsible for BIS in garrison.

The nine BIS are—

- Printing.
- Publications.
- Forms management.
- Reproduction.
- Classified document control.
- Distribution/official mail (E-mail).
- Correspondence.
- Files management
- FOIA/PA.

The signal officer uses the methods of direct action and regulation to supervise the BIS.

**Direct Action.** A central point of contact, under control of the signal officer, receives and routes all requests relating to the service. Only three of the nine BIS require direct action. These are distribution, printing, and FOIA/PA.

Distribution consists of—

- Recommending distribution policies and procedures.
- Internal headquarters distribution.
- Coordinating resources for messenger service.
- Official mail and accountable distribution.
- Distribution center operations and pick-up.

Printing consists of—

- Reviewing and validating printing requests.
- Forwarding print requests to the theater reproduction team.

FOIA/PA consists of—

- Recommending policies and procedures regarding both acts.
- Establishing a point of contact in matters pertaining to either act.

**Regulation.** The signal officer recommends local policies regarding all other services. These BIS occur at the user level. The user is responsible for following Army regulations and local policies recommended by the signal officer.

Users must perform all user level BIS. Any questions regarding policies or use of the BIS should be addressed to the signal officer.

***FM 11-75 covers this subject in more detail.***

## Chapter 2

# Signal Support and Organization

Signal support organizations exist at every echelon of the Army. Their mission is to support the commander by providing reliable and flexible communications, automation, and information services. This support is provided by signal organizations organic to the maneuver unit. At theater, there is a tailored signal command; at corps, a signal brigade; and at division, a signal battalion. In maneuver brigades and battalions, there is a signal staff officer with a section configured to the supported unit.

### Section I.

## Supporting the Corps and Division

### 2-1. Corps Signal Support

The principal signal support organization at corps is the corps signal brigade. Its mission is to provide support through the corps area common-user network. It also provides special staff and technical assistance for planning and controlling all corps signal functions and the extension of signal services to higher and adjacent commands. Figure 2-1 shows an example of the brigade structure. MSE is the principal corps common-user system which provides connectivity to subordinate divisions, adjacent units, joint and allied services, and the Defense Information Systems Network (DISN).



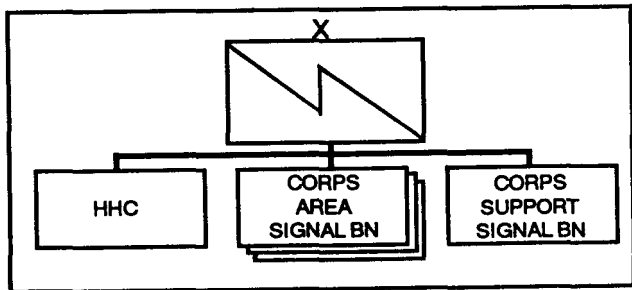

*Figure 2-1. Corps signal brigade.*

## 2-2. Signal Brigade Elements

The corps signal brigade commander serves as both the corps signal officer/G6 and the signal brigade commander. To help accomplish these missions, the commander has the corps signal office/G6, the corps brigade signal staff, and subordinate signal battalions.

**Corps Signal Office/G6.** The corps signal office's primary mission is to perform signal planning for the corps. The corps signal office is part of the corps staff and the assistant corps signal officer (ACSO) oversees the operation of the office. Office functions include—

- Preparing the signal annex's operation plans (OPLANs) for the corps' operations order (OPORD).
- Preparing signal estimates.
- Providing technical supervision of signal activities
- Producing signal brigade taskings based on corps requests.

- Managing all operational and contingency communications security (COMSEC) matters.
- Supervising the corps COMSEC office of record which develops COMSEC OPLANs and policies.
- Supervising the automation section (Maneuver Control System (MCS)).
- Producing tactical telephone directories and listings for corps users.
- Controlling radio frequency (RF) allocations and spectrum management for the corps.
- Coordinating signal interface with host nation and allied forces.
- Managing and controlling corps level BIS functions including the actions of the ISSO.
- Managing the corps' distribution and reproduction section.
- Maintains configuration control of all software by ensuring that the software is current, compatible and standardized.

**Corps Signal Brigade Staff.** The signal brigade implements the corps communications network with the cooperation of the corps staff. The staff consists of—

- Corps signal engineering branch.
- Network control branch.
- Plans/intelligence section.
- Operations section.
- Brigade COMSEC office of record.
- Logistics section.
- Administrative section.
- Automation section.

### 2-3. Subordinate Signal Battalions

**Corps Area Signal Battalion.** These three battalions are responsible for providing communications coverage of a specific portion of the corps maneuver area and for installing a large extension node (LEN) to support the corps command posts (CPs). Also, the corps area signal battalion provides remote North Atlantic Treaty Organization (NATO) interface.

**Corps Support Signal Battalion.** This battalion installs a portion of the corps area network and supports large headquarters at corps. It is configured differently from the area battalions having greater wire assets. Figure 2-2 shows an example of a corps support signal battalion.

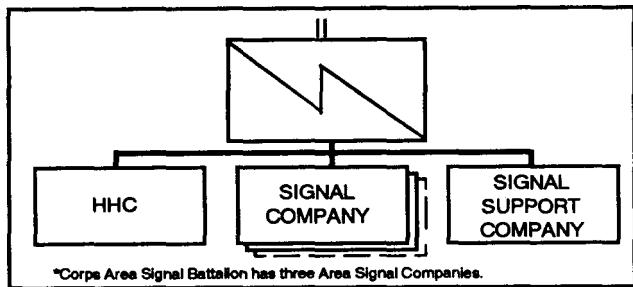

*Figure 2-2. Corps support signal battalion.*

See Appendix B for a corps MSE signal brigade equipment chart.

## 2-4. Division Signal Battalion

The division signal battalion is the principal signal organization supporting the division. Figure 2-3 shows the organizational structure. The battalion's primary mission is to establish a division area common-user network. The signal battalion also provides signal support and staff assistance to plan and control division communications, automation, VI, and BIS.

The division MSE network can operate as a stand-alone network or as part of the corps network. It has the same structure of interconnected node centers (NCs) and extension nodes providing service for division headquarters and major subordinate units. The network can contain gateways to adjacent units and the Defense Communications System (DCS) network.

***See Appendix B for a heavy division MSE signal battalion equipment chart.***

## 2-5. Division Signal Battalion Elements

The division signal battalion commander serves as both the division signal officer/G6 and the signal battalion commander. To help accomplish these missions, the commander has the following assets: the division signal office/G6, the division signal battalion staff, and the subordinate signal companies.

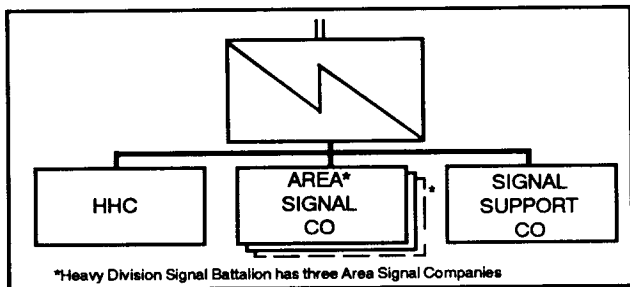

*Figure 2-3. Division signal battalion.*

**Division Signal Office/G6.** The division signal office/G6 works closely with the division G3. The ADSO supervises the division signal office. This office—

- Plans division communications operations.
- Prepares the signal annex to the division OPOD.
- Prepares the signal portion of the division standing operating procedures (SOPs).
- Plans and manages division signal automated systems.
- Prepares the division tactical telephone directory.
- Controls RF allocation and provides spectrum management.
- Acts as the primary interface between the division signal battalion and the division signal officers (BSOs).

- Coordinates signal interface with host and allied nations in stand-alone divisions.
- Prepares and distributes the division signal operation instructions (SOI).
- Coordinates for commercial and/or host nation telephone allocations.
- Requests and manages satellite access for TACSAT.
- Provides BIS to the division while in the tactical environment.
- Maintains configuration control of all software by ensuring that the software is current, compatible and standardized.

**Division Signal Battalion Staff.** The division signal battalion staff assists the commander by providing information, estimates, and recommendations. The staff prepares plans and orders and provides guidance for the design and implementation of the division's communications network. The staff consists of—

- S1 — Administrative Section.
- S2/S3 — Intelligence/Operations and Training.
- S4 — Logistics Section.
- Battalion Maintenance Officer (BMO).
  - Motor maintenance.
  - Electronic maintenance section.

## 2-6. Subordinate Signal Companies

**Battalion Headquarters and Headquarters Company (HHC).** The signal battalion HHC sustains the battalion when deployed through maintenance, logistics, administrative services, and management of the ACUS network.

**Area Signal Company.** The mission of each of the two area signal companies (three in a heavy division) is to provide ACUS coverage for a specific portion of the division maneuver area.

**Signal Support Company.** The mission of the signal support company which contains the division's LEN is to provide support for large CPs such as the division support command (DISCOM). The support company also has TACSAT, net radio interface (NRI), frequency modulated (FM) retransmission, and EPLRS equipment.

**Contingency Communications Package (CCP) Company.** Airborne, air assault, and light signal battalions have a contingency communications company(ies) made up of two identical platoons. Each platoon provides initial MSE and TACSAT capabilities.

**Light Contingency Communications Package (LCCP) Company.** Selected light forces have a contingency communications company made up of two platoons. The LCCP is being developed to provide selected light infantry divisions with an initial MSE capability for a contingency mission. The LCCP closely follows the

organization, concept, and functional characteristics of the airborne CCP, with the major differences exhibited at the extension sites with dismounted equipment.

## **Section II.**

### **Supporting the Maneuver Brigade/ Battalion**

#### **2-7. The Maneuver Brigade/Battalion**

Maneuver brigades are the primary element used for conducting combined arms operations. They consist of at least three infantry, armor, or mechanized battalions. In addition, the brigade may be augmented by other fighting and supporting elements, such as field artillery, air defense artillery, light infantry, engineer, aviation, and chemical units.

The maneuver battalion consists of three or more company-sized units and a headquarters company. Combat arms battalions perform tactical operations to support the brigade's mission. Battalions will normally be reinforced with other combat and combat support (CS) elements to form a task force. Maneuver battalions usually task organize to maximize combat effectiveness. Mechanized infantry and armor platoons make up company teams which comprise a battalion task force.



## **FM 11-43**

Appendix A provides a communications planning guide to assist the brigade/battalion signal officer (BSO)/communications chief in planning reliable, flexible communications support for the maneuver commander.

### **2-8. The Brigade/Battalion Signal Officer**

The BSO is the signal expert to the maneuver commander. He advises the commander and staff on all signal support matters. He works for the unit executive officer (XO) and closely interacts with the S3 and other unit staff officers. As a special staff officer, the BSO—

- Provides technical staff supervision over signal support activities throughout the unit.
- Exercises OPCON of all communications assets assigned or attached to the unit.
- Prepares the signal portion of unit OPORDs, OPLANs, and SOPs.
- Coordinates with next higher echelon signal officer for additional communications support, if required.
- Identifies, coordinates, and provides for task force communication requirements.
- Works with the S2 on electronic countermeasure (ECM) threat and electronic counter countermeasure (ECCM) procedures.
- Works with the S3 on manipulative communications deception and tactical ECCM.
- Coordinates with the supporting signal unit to maintain access to the ACUS.
- Coordinates for maintenance support with the S4.

- Assumes supervisory responsibility for all COMSEC items within the unit to include accountability, distribution, destruction, and security.
- Inspects subordinate unit signal support sections.
- Regularly reviews signal prescribed load lists (PLLs) and ensures scheduled services are done on unit communications equipment.
- Plans and supervises all training for operation and maintenance of signal equipment.
- Provides organizational level COMSEC maintenance to support the unit.

The BSO must develop a routine interaction with the unit staff, and take an active role in the staff planning process. He must ensure the staff understands the capabilities and limitations of the units' organic signal assets and external support. He must take these into account when producing an OPORD, OPLAN, or SOP.

Communications must be planned early and in detail for each phase of the operation. Plan for overwhelming success and catastrophic failure in the base plan and in the contingency plans. Signal support must be integrated and synchronized to support each part of an operation on a changing battlefield. Good terrain analysis, competent asset management, and endless staff coordination produce success.

Planning in support of maneuver operations requires the BSO to thoroughly understand the following elements in great detail: (1) The friendly maneuver plan as developed

## FM 11-43

in staff wargaming (to include contingencies), (2) The enemy threat, both templated and actual as confirmation occurs and/or changes the enemy picture, (3) Terrain, through analysis assisted by products available in combat tactical operation centers (TOCs), (4) Equipment, the BSO must track assets carefully, must have predesignated backup equipment, and must consider other available systems from CS or combat service support (CSS) units if necessary.

The BSO must be technically proficient with all communications equipment in the unit. He must learn as much as possible about the technical features that make the equipment work, and considerations that can make it work better. ***He must exercise troubleshooting skills and ensure the equipment is regularly checked and serviced when in garrison. Before deployment, the BSO should direct a thorough communications rehearsal.***

The BSO must be tactically proficient. This requires understanding the unit's mission. He must be a proactive planner and an aggressive participant of the battle staffs wargaming, synchronization, planning/matrixes, and rehearsals. He tracks the battle closely so he can trigger moving assets against forecasted enemy or friendly events. By tracking the battle, the BSO can anticipate the unit's changing communications needs and position the command, control, communications, and computer (C<sup>4</sup>) assets in the best places to support maneuvers.

The BSO must be an aggressive trainer. He must seek to educate the users at all echelons. He must develop simple and clear explanations that combat users can quickly grasp. Command post operators from commanders to radio operators must be well-trained and capable of independent decisions.

## **2-9. Maneuver Brigade/Battalion Communications**

The brigade/battalion commander must be able to receive, process, and transmit orders rapidly. The brigade/battalion CP is highly mobile and must have a communications system that supports this mobility. Command post communications are provided by the following means:

**Organic Signal Assets.** The maneuver unit performs its own internal communications, using organic signal equipment. The maneuver unit uses the FM radio as the primary means of communication. Within the maneuver unit, there is organic terminal equipment, digital nonsecure voice terminals (DNVTs), mobile subscriber radiotelephone terminals (MSRTs), facsimile machines, and communications terminals (CTs) to enable ACUS access. The unit's assets consist primarily of CNR equipment.

**External Signal Support.** Maneuver CPs can enter the ACUS, which is accessible through radio access units (RAUs) or small extension nodes (SENs) operated by the division signal battalion. The process called dual homing, is a redundant system used to compensate for a failed link.

## FM 11-43

It allows two SENS to link into different nodes, thereby allowing uninterrupted communications should one link fail.

### 2-10. Combat Net Radio

CNR is the primary means of C<sup>2</sup> in the brigade/battalion. The advantage of CNR is it is easily installed and highly mobile. CNR also serves as the primary means of internal communications during movement.

**Nets.** Combat nets are formed by functions, such as operations or logistics, and contain specific groups of users within the unit. The structure of a net depends on the existing situation, command guidance, and available equipment. Figure 2-4 shows a typical command/operations FM net.

**Net Supervision.** The BSO is responsible for ensuring that the users know how to operate the system. This includes—

- Ensuring unit personnel remain proficient on CNR.
- Ensuring all unit radio operators are familiar with proper FM net procedures, antijam plans, and retransmission operations.
- Monitoring FM net discipline and making corrections as necessary.

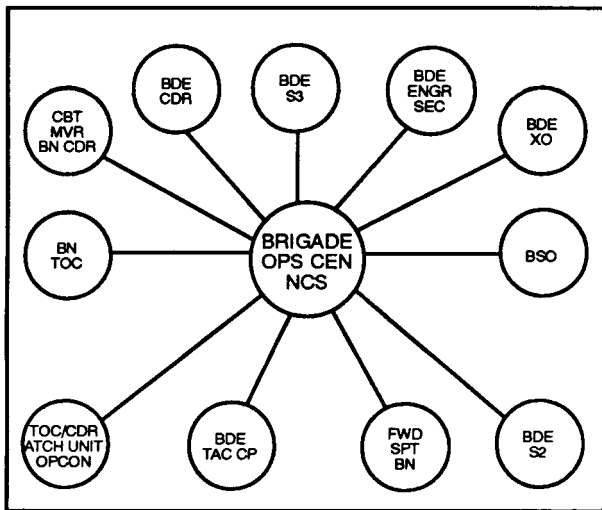

*Figure 2-4. Typical command/operations FM net.*

**Range Extension Systems.** To overcome terrain obstacles or distances between stations, range extension systems are employed. Depending on the situation, some units may have an augmented/transferred range extension system. These include single or multichannel systems, additional FM retransmission systems, HF radio systems, or other expedient methods, such as radio power amplifiers and long-range antennas. The BSO can also take steps to accomplish range extensions by ensuring that FM antennas such as the OE-254, AS-2259, or GRA-50 are employed.

## FM 11-43

Users must understand FM retransmission operations in order to use them effectively.

***See FM 24-18 for additional information on tactical single-channel radio communications techniques to include installing field expedient antennas.***

The BSO is responsible for planning and preparation of retransmission/relay teams being employed throughout the battlefield and provides food and logistical support; except, MSE system maintenance and repair, which is performed by the signal battalion. There are several key factors that facilitate success. They are—

- Integration and synchronization of activities on the battlefield. (See Appendix A, Figure A-9.)
- Risk analysis and waging logical bets with odds. We must plan every mission in detail and for success. (See Appendix C.)
- Analysis and use of terrain. These are both paramount when supporting a retransmission mission. Survivability, sustainment, and accessibility are all key factors when planning a site. (See Chapter 5.)

### **2-11. Area Common-User System**

The ACUS is a common-user communications system that connects all battle command elements.

**Maneuver Brigade Access.** To enable the brigade to enter the ACUS, the division signal battalion provides a SEN to each brigade's TOC and brigade support area (BSA). The SEN teams establish MSE termination sites near the brigade CPs. After the SEN team installs a 26-pair cable from the SEN switch to a J-1077, the maneuver brigade installs the brigade CP's internal wiring. In addition to ACUS access at the brigade CPs, users with MSRTs also may enter the MSE network from their vehicles. RAUs provide this service. Each RAU can process eight subscriber calls simultaneously. The maneuver brigade must also install its own LAN to access the tactical packet network (TPN). Users must also install and properly configure their own battlefield automation devices.

**Maneuver Battalion Access.** MSRTs are remoted in the battalion TOC and the battalion area logistics operation center (ALOC) CPs to provide ACUS access for the battalion TOC and ALOC respectively. Light and heavy units may be configured differently to meet the requirements of that unit. Figure 2-5 shows the different means the maneuver battalion can use to access the ACUS.

**Net Radio Interface.** For users without MSRTs, the signal battalion provides an NRI, so vehicles with FM single-channel radios and SINCGARS can enter the MSE system via a secure digital NRI (TSEC/KY-90).



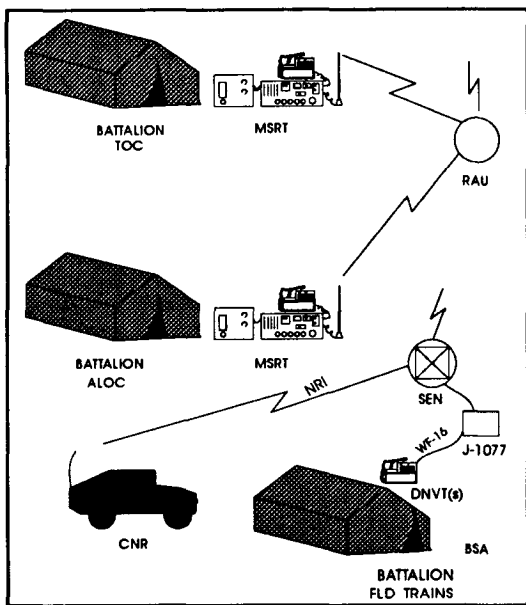

*Figure 2-5. Battalion ACUS access.*

Six NRIs are fielded with each division and corps signal battalion, and they are located at different SENs, LENs, and force entry switches (FESs) across the corps/division area to provide the best coverage. The range of an NRI is equal to the range of the single-channel radio used in that unit.

## 2-12. Cable and Wire

Cable and wire systems provide internal communications for CP and support areas. These wire systems will be extended to subordinate systems when allowed by the tactical situation. Wire communications are used in static or defensive roles. Users are responsible for installing, operating and maintaining their subscriber terminal equipment. They also are responsible for connecting and maintaining their wire lines and LAN cables.

## 2-13. Message Traffic/Data Distribution Capabilities

**Facsimile.** User-owned tactical facsimile machines provide most internal and external mapping, overlay, OPORDs, and reporting traffic. The facsimile currently used is the AN/UXC-7/7A. The AN/UXC-7/7A can transmit one page of data in 7 to 15 seconds. The AN/UXC-7/7A can connect to either SINCGARS or 4-wire ACUS terminations. An advantage of using SINCGARS for facsimile transmission is that it can reach several users at one time.

**Communications Terminals.** The AN/UGC-144 is a formal record traffic CT. This user-owned and -operated device provides most internal and external message traffic. It can store, edit, display, transmit, receive, and print record traffic. This terminal processes in the R (general services) and Y (intelligence) communities at all echelons of the tactical communications systems. However, a separate terminal for each type of traffic must be used.

## FM 11-43

**Couriers.** There is no formal messenger service at the corps or division level. When messenger service is required, the signal officer is responsible for determining routes and schedules. Some units use liaison officers to deliver orders, overlays and messages between CPs. The G3 is responsible for tasking units for vehicles and personnel.

**Tactical Packet Network.** The TPN is overlaid on the MSE network and uses existing trunks exclusively for data transmission. Users can connect personal computers (PCs) and LANs to the TPN from their CPs. Rather than using a direct end-to-end connection, which ties up a whole trunk, the TPN breaks up the data into “packets” and routes them along the most efficient path to their destination. When all packets arrive, the receiving packet switch reassembles the data and sends it to its destination. Each NC, LEN, SEN, CCP, and LCCP provides access to the TPN.

### 2-14. Command Post Planning

Most maneuver units operate from three facilities: the tactical CP (TAC CP), the TOC, and the unit trains.

**TAC CP.** This is where the commander fights the battle. He is assisted by the S3, the fire support officer (FSO), the air liaison officer (ALO), a representative from the S2, and the crews of the assigned vehicles. Sometimes commanders and their FSOs will break from the TAC CP and fight from a separate command group.

**TOC.** This is the primary location for the unit headquarters and is supervised by the unit's XO. The TOC's primary mission is to monitor the current battle, fight the deep battle, and plan future operations. The TOC normally consists of the S2 and S3 sections, the fire support element (FSE), the tactical air control party (TACP), the engineer element, the air defense element, and other attached elements.

**Trains.** Units have two types of trains: combat trains and field trains. The combat trains consist of the ALOC which includes the S1 and S4 section, refuel and ammunition points, aid station, and unit maintenance contact teams. The field trains consist of the Personnel and Administration Center (PAC), food service sections, company supply sections, and the maintenance section. Field trains are controlled by the HHC commander and are located within the BSA. Trains are supported by the forward support battalion under DISCOM. Both trains may be collocated, depending on the operational situation.

**Site Selection.** It is crucial that the signal officer, HHC XO, and unit S3 representative take a prominent role in selecting potential CP sites for the unit. This includes going on reconnaissance of potential "jump" sites. The BSO must work with the staff to choose sites. The S3 should designate potential locations and the BSO should recommend the best location based on the requirements covered below.

## FM 11-43

**Terrain.** Communications are difficult from low valleys, especially when using LOS antennas. Using high ground is best for radio transmissions; however, avoid extremely prominent terrain features that could be used by the enemy as target reference points. The reverse slope of a hill is ideal because it protects from direct fire and still allows for good communications.

**Accessibility.** The site should provide easy access preferably with different entrances and exits. The road should be able to handle various vehicles. Consider access during different weather conditions.

**Space.** Ensure there is enough space for the unit to set up and still have room for communications and support vehicles. Ensure the site is large enough to avoid co-site interference. Plan for a location with a cleared area nearby for a helicopter landing zone in case of required air support.

**Threat.** Consult the S2 and the chemical officer to avoid targeted enemy air assaults and high-speed avenues of approach. If possible, plan for the TAC CP and the command group to be out of enemy artillery range for that phase of the operation. Coordinate with the FSE to place “no fire zones” around all supporting signal sites in the brigade sector.

**Interference.** Locate at least 50 meters away from potential interference from power lines, commercial radio/television stations, or other electronic systems. Understand the frequency spectrum and capabilities of the

system(s) emplaced to prevent co-site interference and manage FM frequencies for correct separation.

Once a site has been chosen, and the unit moves to occupy the site, the BSO must ensure that the site is set up to avoid interference with the unit's communications systems. Figure 2-6 shows an example of a typical brigade CP layout.

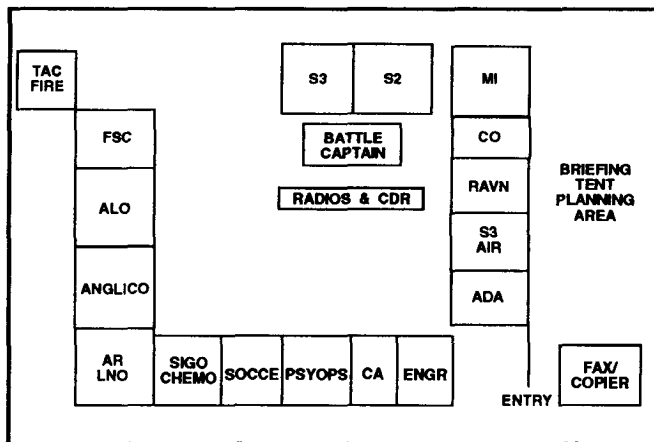

*Figure 2-6. Typical brigade CP layout.*

## FM 11-43

To avoid antenna interference,—

- Place phone lines and cables at least 12 inches away from power cables.
- Centrally locate the J-1077s and install them in the TOC, if feasible.
- Allow the SEN/multichannel team to set up first, if possible.
- Keep antennae away from power sources.
- Keep HF antennae at least 50 meters away from the CP and SINCGARS.
- Keep WF-16 and WD-1 field wire away from other communications lines that may have high RF output, such as CNR antennas and remote cables.
- Space antennae using Table 2-1 as a guide. Antennae can number up to 30 within a 200-meter radius at brigade without multiplexer. Antenna dispersal is especially critical in FM frequency hopping operations.

**Table 2-1. Antenna separation.**

FREQUENCY SEPARATION	MINIMUM DISTANCE BETWEEN ANTENNAS
10 MHZ	5 feet
7 MHZ	60 feet
4 MHZ	150 feet
2 MHZ	400 feet
1 MHZ	800 feet

## Chapter 3

# Area Communications Systems

### 3-1. Overview

The tactical ACUS is a network switching system that provides voice and data traffic interconnectivity for subscribers. EAC use the TRI-TAC systems; ECB use the MSE system. These systems link to provide a seamless area communications system across an entire theater of operations (see Figure 3-1). This chapter provides an overview of both systems.

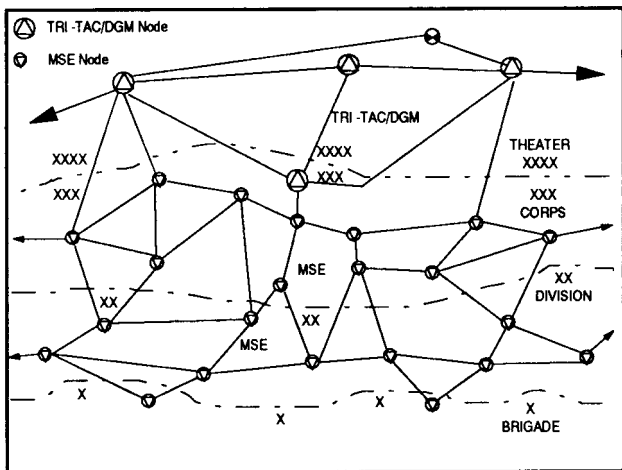

*Figure 3-1. Area communications systems.*



### 3-2. Mobile Subscriber Equipment

**Employment.** The MSE system is the primary ACUS configuration for ECB. MSE forms a network that covers the area occupied by unit subscribers. For a division, the grid is made up of four to six centralized NCs which make up the hub or backbone of the network. Throughout the maneuver area, subscribers connect to SENS/LENS by radio or wire. These extension nodes serve as local call switching centers and provide access to the network by connecting to the NCs. See Figure 3-2.

**NOTE:** *For the following radio configurations not all switches have super high frequency (SHF) radios. SHF radios are allocated on the basis of about one to every two switches.*

**System Features.** The MSE system is an area-switched communications system. The system provides communications for a notional five-division corps in an area of operations of up to 15,000 square miles (37,500 square kilometers). The system is digital, secure, highly flexible, and contains features that deal with link or functional element outages, traffic overload, and rapid movement of users. The MSE system provides both voice and data communications on an automatic, discrete addressed, fixed-directory basis using flood search routing. The system supports both mobile and wire subscribers in the five-division corps with a means to exchange command, control, communications, and intelligence information in a dynamic tactical environment.

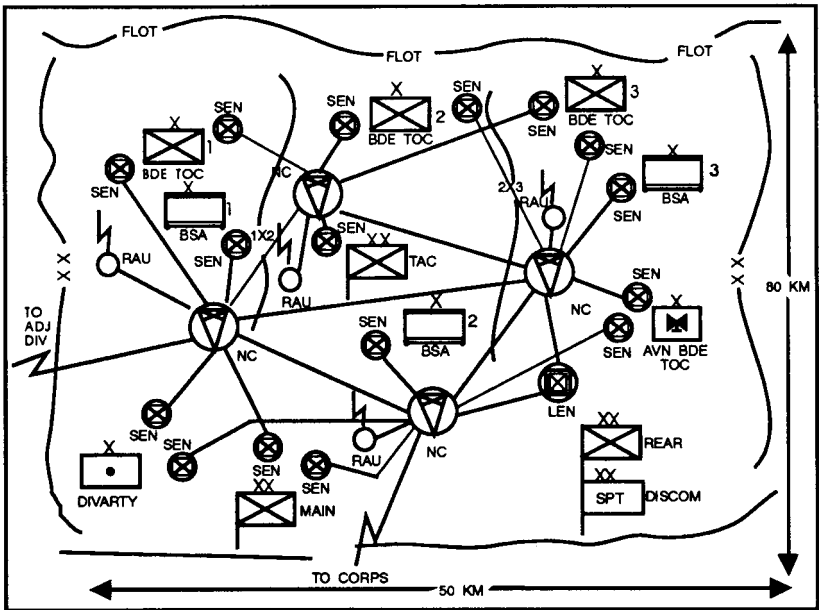

Figure 3-2. Light division ACUS.

## FM 11-43

The TPN is a packet switching network that is overlaid on the circuit switching network of MSE. Along with providing data communications with the corps structure, the TPN provides data interoperability with adjacent corps and EAC forces, NATO forces, and commercial networks.

**Power Requirements.** Diesel engine driven generators provide alternating current (AC) power to assemblages/shelters. The two types of power units, as well as the shelter carrier alternator used in the MSE system are listed in Table 3-1 with their respective operating data. Vehicles equipped with the 200-ampere alternators provide direct current (DC) power as backup during site setup or generator start up, maintenance, or refueling. The shelter battery bank provides up to ten minutes of power between time of generator shutdown and vehicle engine (and 200 ampere alternator) start up. The figures in Table 3-2 reflect fuel consumption under full load conditions.

*Table 3-1. Shelter power requirements.*

EQUIPMENT	POWER REQUIREMENT (kW)	POWER UNIT
NC SWITCH: switching and operations shelters	8	PU753/M
LEN SWITCH: switching and operations shelters	8	PU753/M
MANAGEMENT FACILITY	3.5	PU753/M
SEN( ) SWITCH	5	PU753/M
RAU	4	PU751/M
LOS( )	3	PU751/M
SCC:		
Management and technical shelters	7	PU753/M
Planning shelter	5	PU751/M

*Table 3-2. Fuel consumption.*

TYPE	FUEL CAPACITY (GALLONS)	FUEL CONSUMPTION (GALLONS/HR)	POWER RATING (kW)	FREQUENCY (Hz)
PU751/M	6.75	0.84	5	60
PU753/M	12.5	1.56	10	60
Alternator (shelter carrier)	25.0	0.8	378	N/A

**NODE CENTER**

**Function.** NCs serve as an access point for LENSs, SENs, RAUs, and system control centers-2 (SCC-2s). Each NC operates as an automatic switching point that receives traffic and routes it to other switches through flood search. The NC site contains two shelters, one for switching and one for operations, four LOS(V)3 multichannel terminals, one local RAU, and a node management facility (NMF). See Figure 3-3.

**Connectivity.** Most NC traffic is passed between the NC switch and the four LOS(V)3 multichannel radio assemblages. Each LOS(V)3 passes three digital transmission groups (DTGs) multiplexed into one multiplex DTG (MDTG) to the NC switch. The NC switch also can cable directly to two SENs, a RAU, and an SCC-2. In addition to the LOS assemblages, the NC connects to multichannel TACSAT/tropospheric scatter (TROPO) systems, or allied subscribers. Twenty-four local telephones are available for NC personnel.

**Node Management.** The NMF contains a workstation, an intercom, a DNVF, a digital voice orderwire (DVOF), a mapboard, and workspace. The workstation has a monitor and keyboard, and it communicates with the SCC-2 to update NC/LEN status and to receive operational messages and directives. The NMF does not have a printer. It accesses the operations shelter's printer.

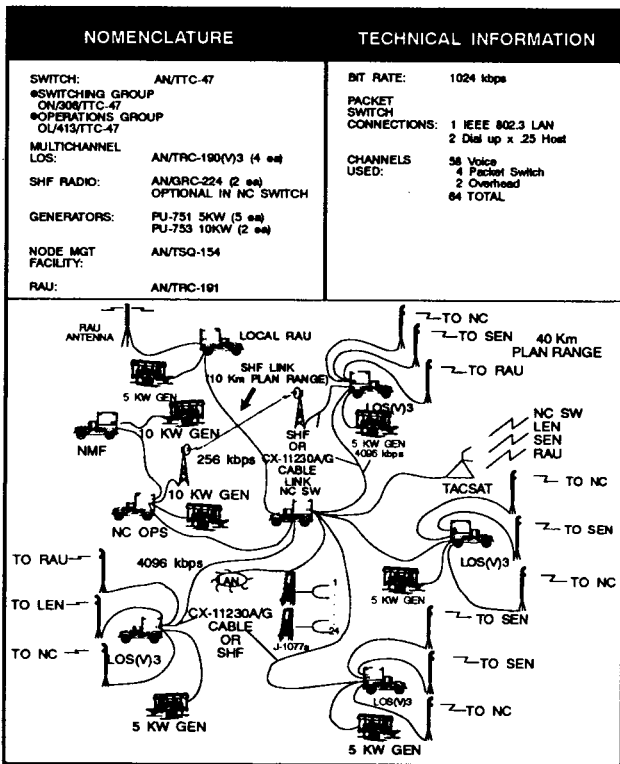
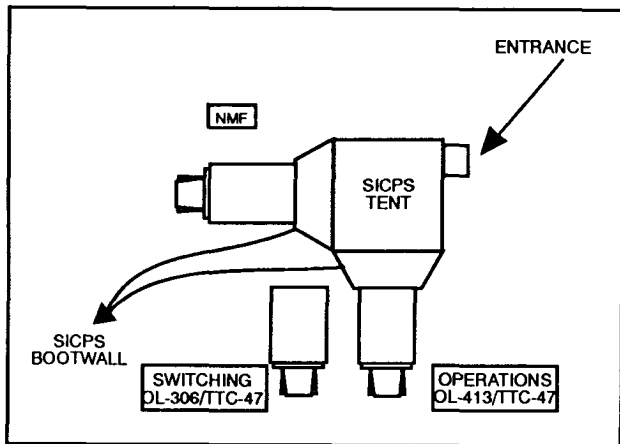

Figure 3-3. Typical NC configuration.

## FM 11-43

The Standard Integrated Command Post System (SICPS) tent is used in conjunction with the NMF to make up the operations center. It contains the basic equipment and charts from the NMF. Figure 3-4 shows a typical operations center layout and Figure 3-5 shows a typical node operations board.



*Figure 3-4. Nodal operations.*

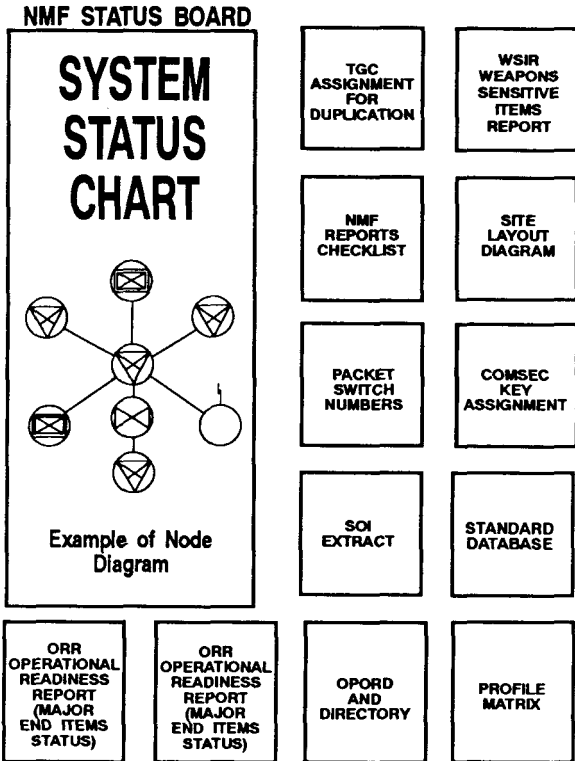

*Figure 3-5. Typical node operations board.*



**LARGE EXTENSION NODE**

**Function.** The LEN consists of two shelters, one for switching and one for operations, an LOS(V)4 multichannel terminal, and an NMF. The LEN provides ACUS access to large groups of users in areas where mobility and dispersion are not primary considerations. See Figure 3-6. The LEN usually deploys to support large CPs such as the corps support command (COSCOM) and the DISCOM.

**Interconnectivity.** Eighty-four of the LEN subscribers install wire from their telephones to the J-1077 and the remaining 80 connect to remote multiplexer combiners (RMCs). These are cabled to the switch that connects to the LOS(V)4 either through CX-11230A/G cables or SHF links. Two LOS shots from the LOS(V)4 provide links to two different NCs. If the situation dictates, a SEN or RAU can connect to the LEN. Like the SEN, the LEN may connect to a multichannel TACSAT and may provide 2- or 4-wire connections for commercial switches.

**Node Management.** The NMF for a LEN is the same as the NMF for the NC. The SCC-2 connects to the LEN switch by CX-11230A/G cable. The LEN uses the same SICPS configurations as shown in Figures 3-4 and 3-5.

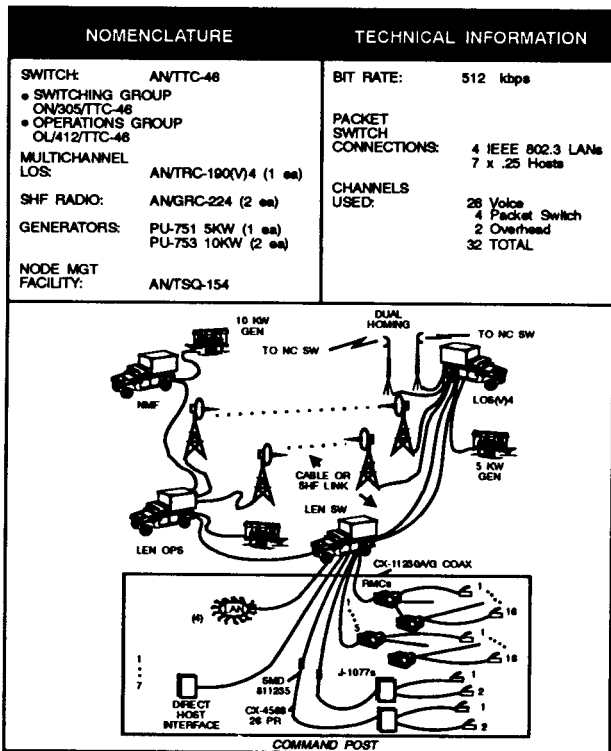

Figure 3-6. Typical LENO configuration.

**SMALL EXTENSION NODE**

**General.** The SEN has two assemblages, the SEN switch and its supporting multichannel LOS radio terminal. The SEN provides ACUS access to smaller units such as battalion or brigade CPs. Currently, there are five different models of the SEN switch. (See Table 3-3.) The AN/TTC-48A(V)2 is used at EAC. The four remaining models are AN/TTC-48(C)1, 2, 3, and 4. The two configurations of the SEN are: the SEN(V)1 services 26 subscribers and the SEN(V)2 services 41. See Figure 3-7.

SEN teams must rapidly and aggressively seek to incorporate themselves into the CP they support. Threats, updates, casualty evacuation procedures, nuclear, biological, chemical (NBC) and early warning (air) procedures must be understood as well as the SENs responsibility in the site's defense. As the signal battalion representative, SEN chiefs must circumvent problems, keeping the unit BSO and battle staff well informed of system status and actual/potential problems.

**Interconnectivity.** Local users install wire from their telephones to a J-1077 which the SEN team connects to the switch. External connection to the NC is made by a LOS(V)1 at the SEN site. If the SEN switch is near its parent NC switch, it can be connected by cable. An SHF radio link can connect the LOS(V)1 to the SEN switch up to 10 kilometers away. This enables the remoting of the CP which reduces its RF signature. Also, the SHF link

overcomes time, distance, and terrain limitations (down-the-hill radio). The SEN switch connects to multichannel TACSAT, AN/TSC-85 or AN/TSC-93 terminals by CX-11230A/G or CX-4566 (26-pair) cables. This facilitates range extension of the ACUS.

**Interoperability.** The SEN switch provides 2-wire (DC closure) for direct access to commercial switching offices. CNR users can access the MSE system through the secure digital NRI (KY-90). The AN/VRC-46, AN/VRC-90, AN/PSC-3, or the AN/VSC-7 satellite radio systems are compatible with the KY-90 NRI unit.

*Table 3-3. SEN models.*

Model	Capability/Equipment
AN/TTC-48 C(V)3 and C(V)4	Loop Group Multiplexer, TD-1426(P)/T
AN/TTC-48 C(V)3 and C(V)4	Group Modem MD
AN/TTC-48 C(V)3 and C(V)4	Orderwire Control Unit, C-11678/T
AN/TTC-48 A(V)2, C(V)1, and C(V)2	Communication Modem, MD-1270(P)/T
AT/TTC-48 C(V)1, C(V)2, C(V)3 and C(V)4	Signal Data Converter/ThinLan Packet Switch C/3XA (operational)

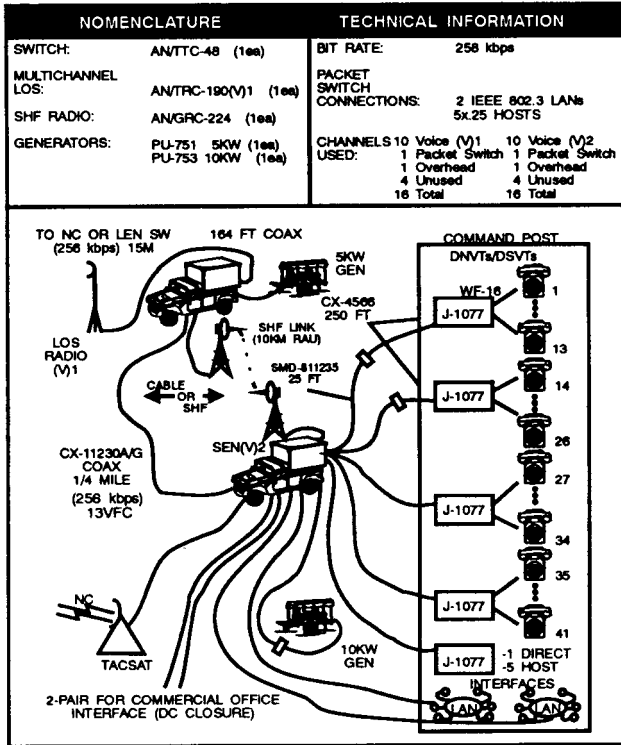

Figure 3-7. Typical SEN configuration.

**LINE-OF-SIGHT RADIO LINKS**

**General.** LOS radio links are multichannel digital radio systems which connect all MSE nodes. The LOS radio uses a 15-meter mast antenna system; however, a 9-meter mast antenna may be used to establish an SHF downhill radio link with the switch. There is one 30-meter mast antenna per NC and can be used if the radio link is profiled for it. The AN/TRC-190 assemblages provide these radio links. The radios operate between 225 and 400 MHz and between 1350 to 1850 MHz.

**Configurations.** The four LOS AN/TRC-190 versions are: (V)1, (V)2, (V)3, and (V)4. (See Table 3-4.) The LOS(V)1 interfaces with a RAU, SEN, FES, and the air defense artillery (ADA) interface unit. The LOS(V)2 interfaces with the NATO analog interface (NAI) converter. The LOS(V)3 interfaces with the NC switch and can be a radio relay or provide a digital NATO interface (DNI). See Figure 3-8. The LOS(V)4 interfaces with a LEN switch as a radio relay and an ADA interface. The AN/TRC-198(V)1 and (V)2 are used in the airborne/air assault, light signal battalion which uses the more compact MSE system, the CCP.

## FM 11-43

**Planning.** MSE network planners select the radio band, antenna polarization, site location, and interface used between the LOS and the switch before deploying LOS shelters. The information passes from system control/battalion control (SYSCON/BATCON) through the MSE network as open link messages for implementation.

*Table 3-4. LOS radio link configuration.*

LOS	#OF RADIOS	# OF RADIOS USED SIMULT	#OF ANTENNAS BND 1 BND 3	MUX	DTGs kbps	SHF
AN/TRC-190	2	1	1+1	0	1/256	1
V1						
V2	2	1	1+1	1	1/256	0
V3	4	3	2+2	1	3/4096	1
V4	2	2	1+1	0	2/512	2
AN/TRC-198	3	3	3 or 3	0	1/256	0
V1	1	1	1 or 1	0	1/256	0
DISMOUNTED V2						

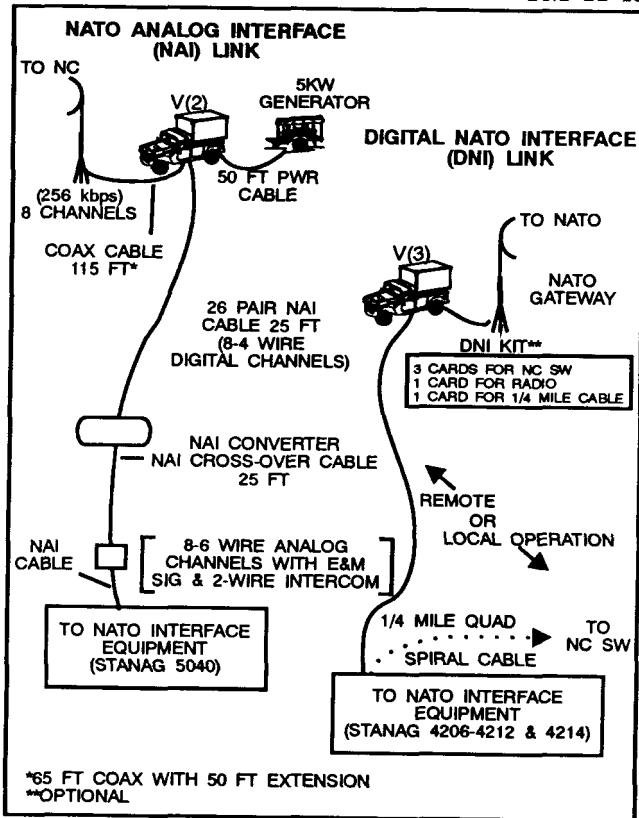
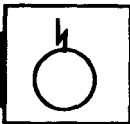

Figure 3-8. Typical LOS(V)2 NATO analog interface link and LOS(V)3 digital NATO interface link.



**RADIO ACCESS UNIT**

**Function.** The RAU gives each mobile subscriber secure, wireless access to the ACUS. Subscribers within the RAU's 15-kilometer range use their MSRTs to connect to the MSE network through the RAU. The RAU receives the transmissions and passes them to the NC switch. See Figure 3-9.

**Deployment.** RAUs are used in two configurations. In a local RAU, the RAU assemblage is collocated with the NC and connects to the NC switch by cable. A remote RAU can be up to 40 kilometers away from the NC connected by an LOS(V)1 at the RAU site.

Remote RAU teams deploy alone; consequently, the team must be well briefed on both the friendly maneuver and the enemy situation. RAU teams must understand routes, rally points, casualty evacuation procedures, decontamination data, and early warning (air) procedures. The team chief must maximize use of terrain, vegetation, or buildings for concealment and maintain constant security. RAU teams require constant threat updates and must be quickly moved if necessary. Movement should be planned in detail to prevent fratricide. These same considerations apply to an LOS(V)3 radio when being used as a relay.

**Users.** A RAU can support customers within a 15-kilometer radius. Each RAU has eight radios that allow eight subscribers to talk simultaneously, although as many

as 50 can share the same RAU. Three RF levels (16W, 3W, and .5W) are delivered to the antenna. The RAU selects the lowest working output automatically. Affiliation is the process by which subscribers enter and identify their location within the network. The subscriber affiliation is obtained by keying 8R followed by the three-digit personal code and seven-digit directory number. Successful affiliation results in the subscriber receiving a dial tone and the ability to initiate and receive telephone calls. Once a subscriber initially affiliates into the network with their MSRT, their affiliation is maintained automatically as they move from one RAU's range to another.

BSO's should advise their users, when they are moving from one RAU footprint to another, they will lose their telephone call and must reestablish it.

System planners and managers analyze terrain to select the best RAU location before deployment. Dead spots should be briefed to the unit and subordinate units during the rehearsal for an operation. Additionally, high and low terrain that assist or mask the possible execution of MSRT or FM operations should be highlighted so that the terrain can be used to its maximum advantage.

Careful consideration for density of subscribers and maximum amount of traffic must be used in determining the planning ranges of RAUs.

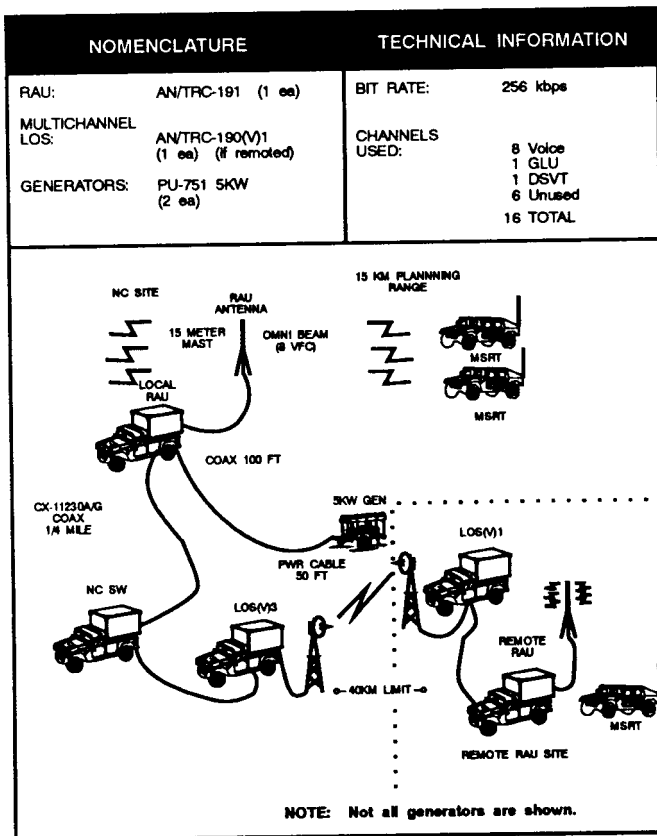

Figure 3-9. Typical RAU configuration.

**SYSTEM CONTROL CENTER-2****SCC-2**

**Function.** The SCC-2 is a computer-assisted, automated tool that helps SYSCON cells manage the network. It consists of a technical shelter, management shelter, and planning shelter (corps only). It is collocated within the SYSCON and provides the information for network management. See Figure 3-10.

**Deployment.** At corps, three SCC-2s deploy: two primary and one standby. The three are interchangeable. At division, there is one SCC-2 and it consists of the technical and management/planning shelters. The division SCC-2s are subordinate to the corps primary SCC-2, unless the division is in a stand-alone configuration.

**Connectivity.** The SCC-2 connects to an NC or LEN switch by CX-11230A/G cable. All network SCC-2s receive regular database updates from each other through a packet switch in the technical shelter. All traffic from the SCC-2 to the NCs, LENs, FESSs, and RAUs is routed through the circuit switch.

Each SCC-2 has a technical shelter. The shelter has two computers: The transmission interface module (TIM) and the packet switch. One computer is usually used as the technical workstation, and the other is the packet switch controller. The TIM connects the SCC-2 to the other 16-channel trunk group from the NC switch.

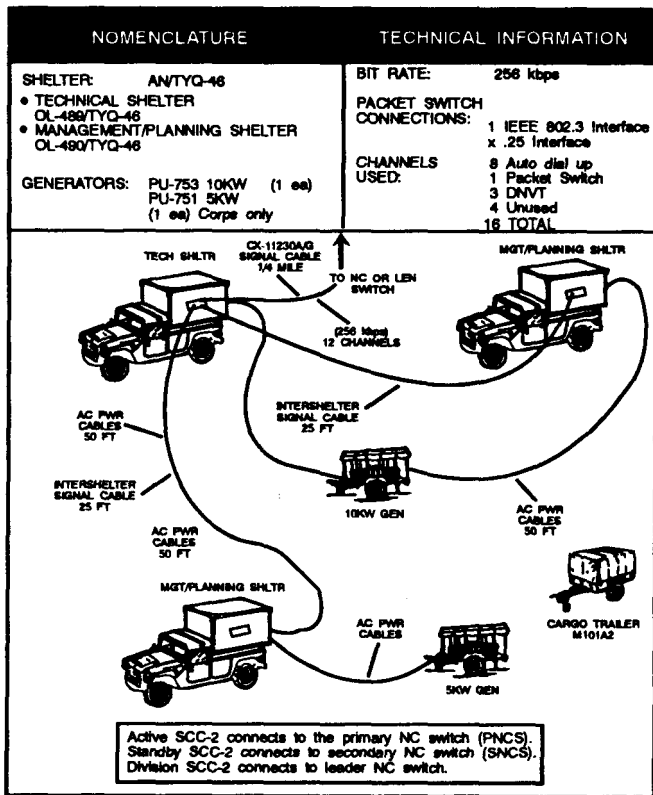

Figure 3-10. Typical corps SCC-2 configuration.

The packet switch controller serves as the network management center. The switch controller is in the SCC-2. However, it does not control any circuit switch assets, or calculate radio links. It controls and monitors the packet switch network (PSN). It does not provide interaction with the circuit switch network.

The technical workstation acts as the focal point for the SCC-2. It controls the message traffic within, into, and out of the SCC-2. It assigns system management responsibilities to the other workstation and maintains the SCC-2 network database for all workstations. It also provides map data to the other workstations and passes along updates from the other SCC-2s in the network.

The SICPS tent is used to makeup the SCC-2 operations center. This configuration may be set up differently to meet mission requirements. There are only two shelters used in the division SCC-2 configuration as opposed to the three which are shown in Figure 3-11.

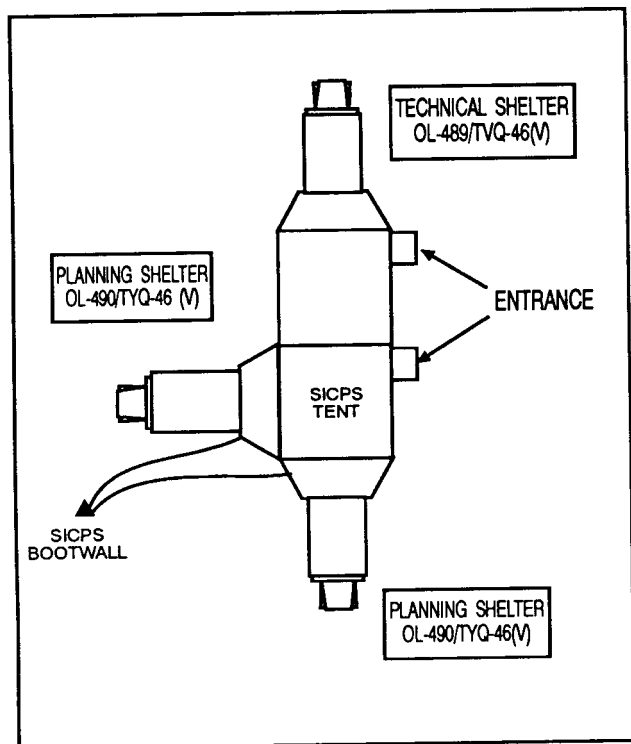

Figure 3-11. Corps SCC-2 operations.

**CONTINGENCY COMMUNICATIONS PACKAGE**

**Contingency Communications Package (CCP).** A CCP consists of four basic elements:

- One contingency communications parent switch (CCPS) which combines the essential functions of the NC switch/LEN/NMF shelters and a RAU in a single FES shelter and an LOS(V)TRC-198; the FES supports 25 affiliated mobile subscribers.

- Two contingency communications extension switches (CCEs), which include an FES and a dismantled LOS (DLOS).

- One extra dismantled extension switch (DES), which is essentially an “unsheltered” SEN switch with half its capacity and an extra DLOS.

The FES interfaces with an SCC-2, the AN/TYC-39 message switch, the AN/TTC-39A and the AN/TTC-39D circuit switches, the NAI, and the DNI.

A typical CCP mission (initial deployment) can be airlifted in two C-141B sorties. See Figures 3-12A, B, C, 3-13, and 3-14.



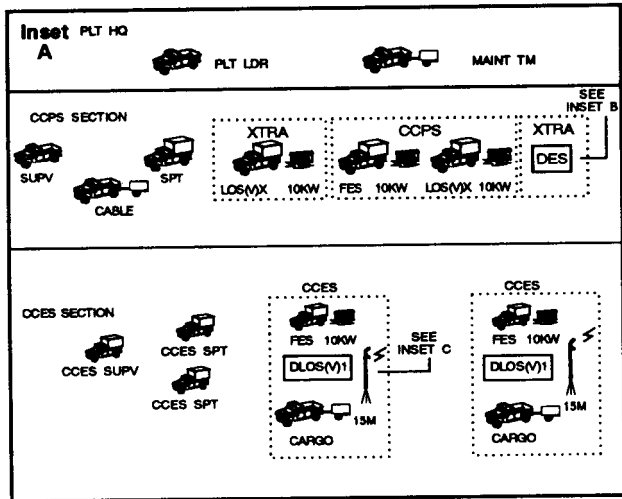

LEGEND

- LOS(M)X - LOS W/3 COMPLETE  
GRC-228 RADIO SETS
- DLOS(V)1 - DISMOUNTED LOS(V)1

INITIAL DEPLOYMENT

SORTIE #1

- 1 FES WITH 10KW GEN
- 1 TACSAT WITH 10KW GEN
- 1 TACSAT SPT VEHICLE WITH CARGO TRAILER

SORTIE #2

- 1 LOS(M) X WITH 10KW GEN
- 1 CCP SPT VEH WITH CARGO TRAILER
- 1 FES WITH 10KW GEN

Figure 3-12A. Contingency communications platoon.

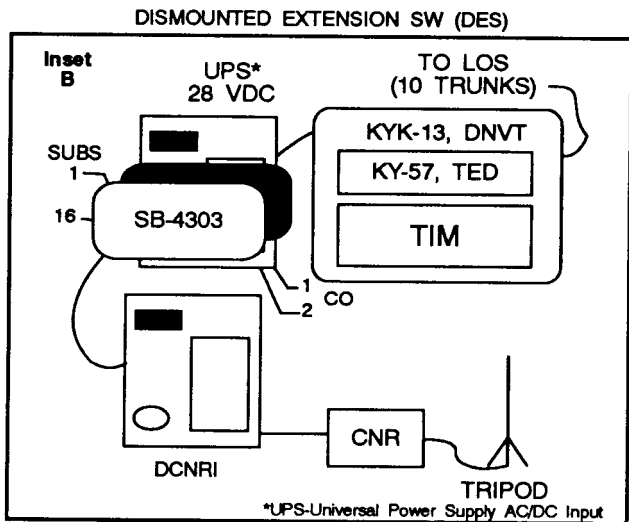
LEGEND

LOS(V)X - LOS W/3 COMPLETE  
GRC-226 RADIO SETS  
DLOS(V)1 - DISMOUNTED LOS(V)1

INITIAL DEPLOYMENT

## SORTIE #1

- 1 FES WITH 10KW GEN
- 1 TACSAT WITH 10KW GEN
- 1 TACSAT SPT VEHICLE WITH CARGO TRAILER

## SORTIE #2

- 1 FES WITH 10KW GEN
- 1 LOS(V)X WITH 10KW GEN
- 1 CCP SPT VEHICLE WITH CARGO TRAILER

*Figure 3-12B. Contingency communications platoon.*

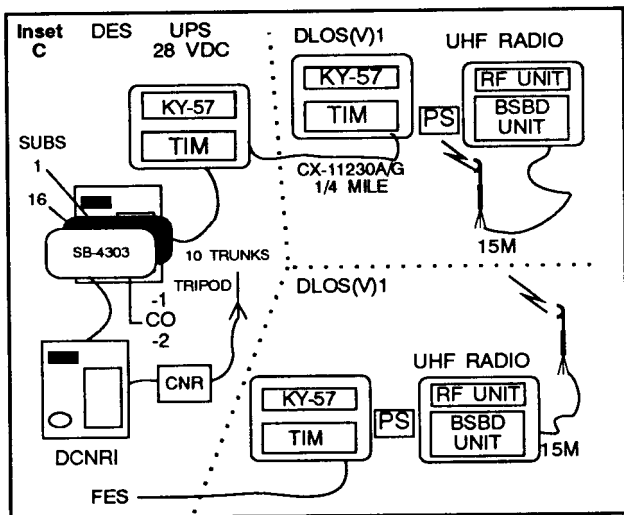

LEGEND

- LOS(V)X - LOS W/3 COMPLETE GRC-228 RADIO SETS
- DLOS(V)1 - DISMOUNTED LOS(V)1

INITIAL DEPLOYMENT

SORTIE #1

- 1 TACSAT WITH 10KW GEN
- 1 TACSAT SPT VEH WITH CARGO TRAILER
- 1 FES WITH 10KW GEN

SORTIE #2

- 1 FES WITH 10KW GEN
- 1 LOS(V)X WITH 10KW GEN
- 1 CCP SPT VEH WITH CARGO TRAILER

Figure 3-12C. Contingency communications platoon.

A and B = CCP mission (INITIAL DEPLOYMENT).  
 A, B, and C = CCP mission (FULL DEPLOYMENT).

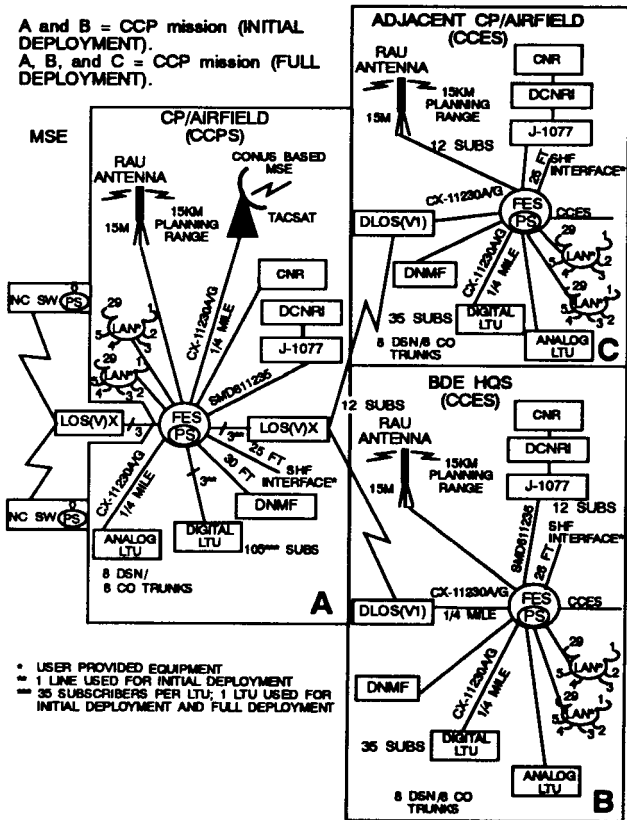

Figure 3-13. CCP conventional mission in its entirety.

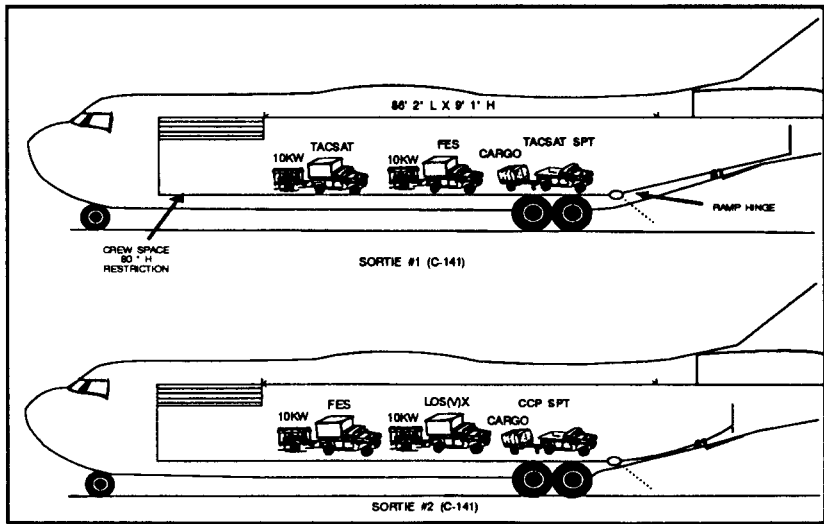

Figure 3-14. CCP initial deployment.

**Contingency Communications Parent Switch (CCPS).** The CCPS consists of one FES shelter towing a 10-kilowatt diesel generator, and one LOS(V)X that can dismount one LOS(V)1. The connections between the FES and the LOS are by cable initially, since no SHF is supplied. The FES can be operator-controlled external to the shelter by a dismountable remote terminal, which can be configured as a workstation or a dismountable NMF (DNMF). The FES has packet switch capability, but without the gateway function; hence, no direct connections to adjacent corps or EAC. The packet switch provides ports for two LANs and six X.25 local hosts, plus one dial-in port. The FES provides full flood search capability via a downsize routing subsystem (RSS-D) and an SHF interface capability and a digital subscriber voice terminal (DSVT) in the truck. The line termination unit (LTV) provides modem/multiplex functions for the main local subscriber interface and is equipped with a rear terminal board to permit direct connections instead of the J-1077.

The LOS(V)X is similar to an LOS(V)3, except that the LOS(V)X's ultra high frequency (UHF) radios operate on three separate link connections to the FES (no multiplex) and all links operate on either band.

The CCPS provides service for a total of 117 wire line subscribers including eight defense switching network (DSN) and eight commercial analog trunks.

## FM 11-43

Additionally, the FES provide a a fully functional, downsized RAU capability for up to 25 mobile subscribers as well as dismantled combat net radio interface (DCNRI) access for single-channel radio users.

The CCPS supports the brigade headquarters with parent node capabilities and provides local switching for the mobile subscriber and local wire subscribers with appropriate interfaces with CNR, commercial access, TACSAT, DSN, and packet switch. Figure 3-15 shows a typical CCPS deployment. The power subsystem is similar to the NC switch.

**Contingency Communications Extension Switch (CCES).** The CCES consists of one FES shelter towing a 10 kilowatt generator, one dismantled LOS(V)1 with one radio with Band 1 and Band 3 capabilities, and one cargo high mobility multipurpose wheeled vehicle (HMMWV) with cargo trailer. Figure 3-16 shows a typical CCES.

The CCES provides the same wire, mobile and DCNRI capabilities as the CCPS; however, the quantity of LTU's limits wire access to 47 subscribers including eight DSN and eight commercial analog trunks.

**Dismounted Extension Switch (DES).** The DES provides access for 16-local wire subscribers with access to over 10 digital encrypted trunks to the MSE network via LOS or TACSAT. The DES consists of one of the two SB-4303s that populate a SEN switch.

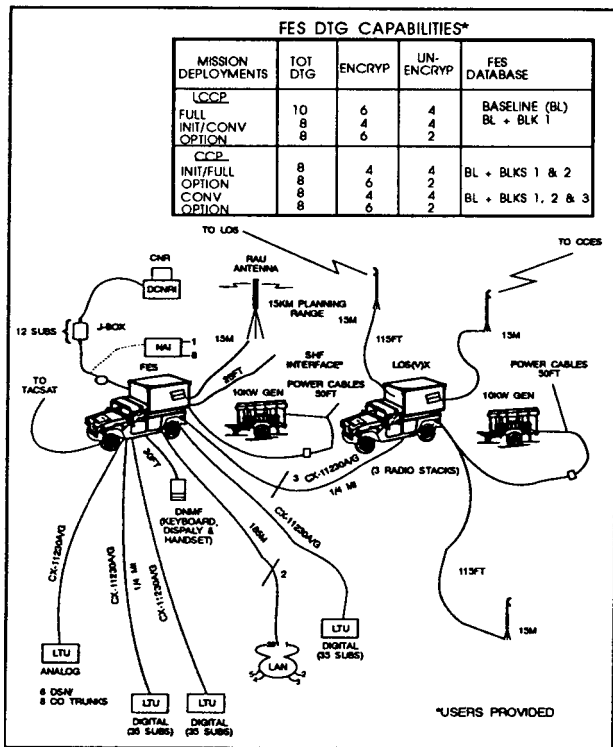

Figure 3-15. Typical CCPS deployment.



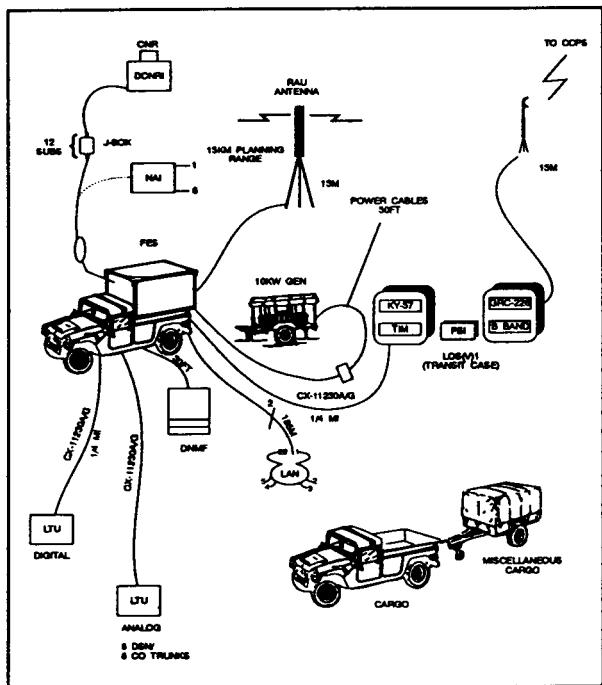

Figure 3-16. Typical CCES.

**LIGHT CONTINGENCY COMMUNICATIONS  
PACKAGE**

**Light Contingency Communications Package (LCCP).** The LCCP consists of two basic elements

- One CCPS which combines the essential functions of the NC switch/LEN/NMF shelters and a RAU in a single FES shelter and an LOS(V)X.
- Two light contingency communications extension switches (LCCESs).

The main difference between the LCCES and the CCES is that the LCCES' equipment is dismountable.

A typical LCCP contingency mission (initial deployment) can be airlifted in two C-141B sorties. See Figures 3-17A, B, 3-18, and 3-19.

**Light Contingency Communications Extension Switch (LCCES).** This switch performs functions similar to the CCES in the CCP. The main differences between the LCCES and the CCES is that the LCCES' equipment is dismountable, unlike the CCES' equipment.

This subsystem differs considerably when compared to its counterpart the CCP. The major differences are that all the equipment is dismountable and the switch is a DES (essentially half a SEN switch); there are no shelters, and the only vehicle is the cargo vehicle and it a trailer which are required to carry the dismounted equipment.

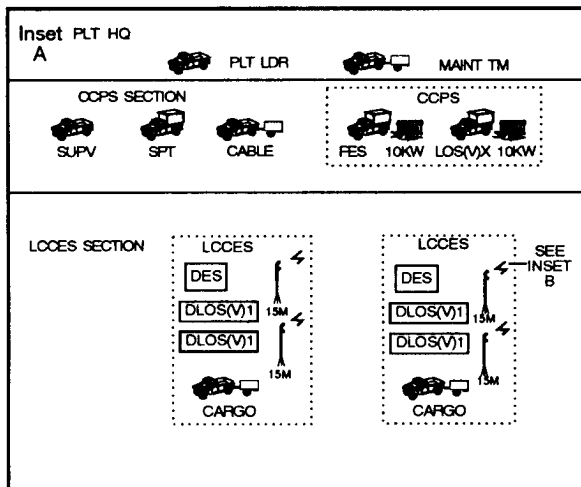

LEGEND

- LOS(V)X - LOS W/3 COMPLETE  
GRC-228 RADIO SETS
- DLOS(V)1 - DISMOUNTED LOS(V)1

INITIAL DEPLOYMENT

SORTIE #1

- 1 TACSAT WITH 10KW GEN
- 1 TACSAT SPT VEHICLE WITH CARGO TRAILER
- 1 FES WITH 10KW GEN

SORTIE #2

- 1 LOS(V)X WITH 10KW GEN
- 1 LCCP SPT VEHICLE WITH CARGO TRAILER
- 1 FES WITH 10KW GEN

*Figure 3-17A. Light contingency communications platoon.*

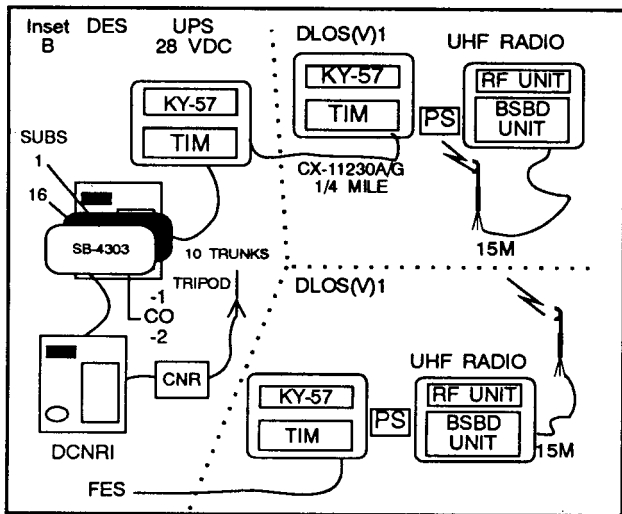
LEGEND

- LOS(V)X - LOS W/3 COMPLETE  
GRC-226 RADIO SETS  
DLOS(V)1 - DISMOUNTED LOS(V)1

INITIAL DEPLOYMENT

- SORTIE #1
- 1 FES WITH 10KW GEN
  - 1 TACSAT WITH 10KW GEN
  - 1 TACSAT SPT VEH WITH CARGO TRAILER
- SORTIE #2
- 1 LOS(V)X WITH 10KW GEN
  - 1 LCCP SPT VEHICLE WITH CARGO TRAILER
  - 1 FES WITH 10KW GEN

*Figure 3-17B. Light contingency communications platoon.*

A and B = LCCP mission (INITIAL DEPLOYMENT).  
 A, B, and C = LCCP mission (FULL DEPLOYMENT).

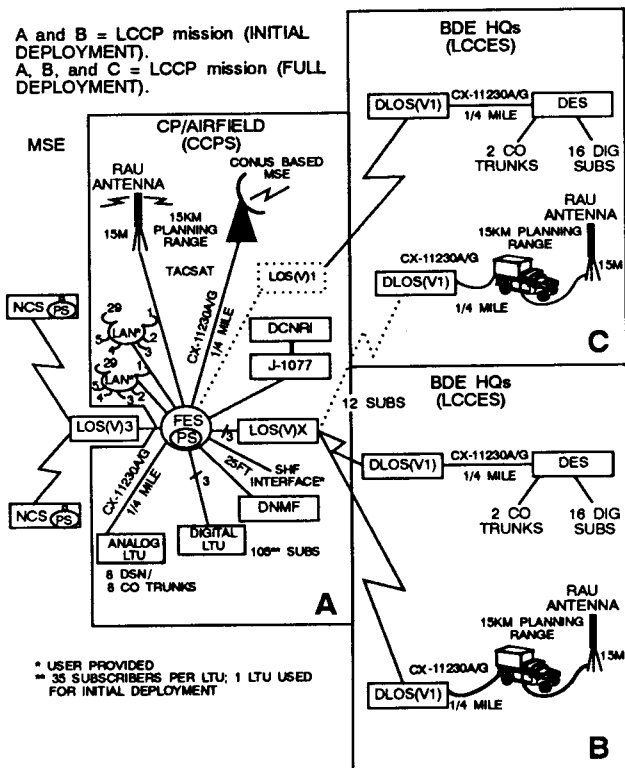
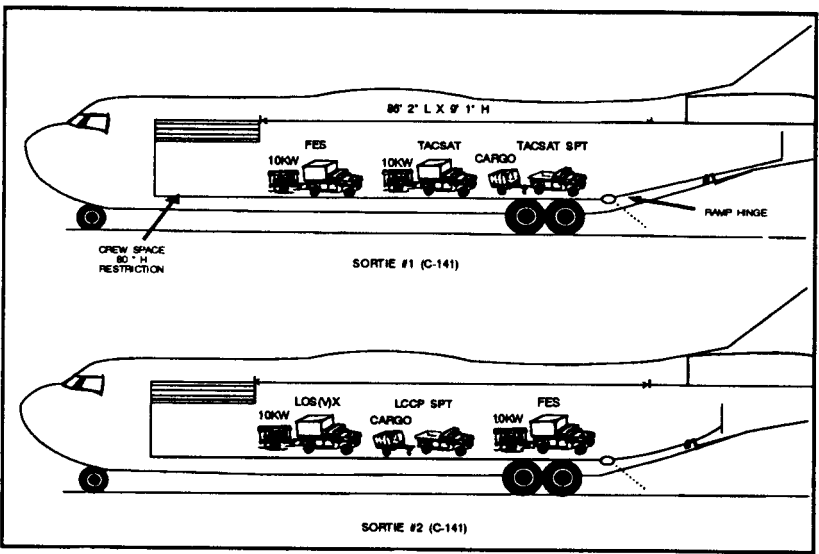

Figure 3-18. LCCP conventional mission in its entirety.



*Figure 3-19. LCCP initial deployment.*

## **FM 11-43**

**Light Contingency Communications Parent Switch (LCCPS).** The LCCPS is configured identically to the CCPS.

**Databases.** The baseline (BL) FES database has been written to support LCCP full mission deployment. However, this BL database can be modified for other missions (LCCP and CCP). Once the operator implements the block procedures, they can be saved to the hard or floppy disks for future use.

**MSE STANDARD DATABASE**

**Function.** The MSE standard database is loaded by the software in the NC switch and LEN switch. This database is standardized for every NC to maintain consistency throughout the MSE network. The standardized setup means that each DTG entering the NC switch is assigned its own specific trunk group cluster (TGC) number and trunk encryption device (TED). This particular DTG has the same TGC and TED at every NC in the MSE system. Also, each MDTG will always contain the same three DTGs. However, since the needs of each NC differ, modify the database when the situation dictates

Assigning DTGs affects the NC site layout for cabling and antenna configurations, since each LOS(V)3 shoots to the same type of sites. Figure 3-20 shows the standard database configuration for the NC switch. Figure 3-21 shows the standard database configuration for the LEN switch. Table 3-5 shows commonly used COMSEC keys required for the initialization of the MSE system.



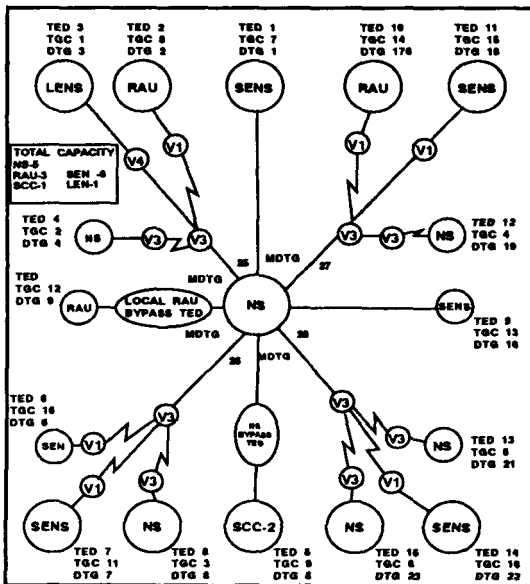

Figure 3-20. NC switch DTG/TGC standard database.

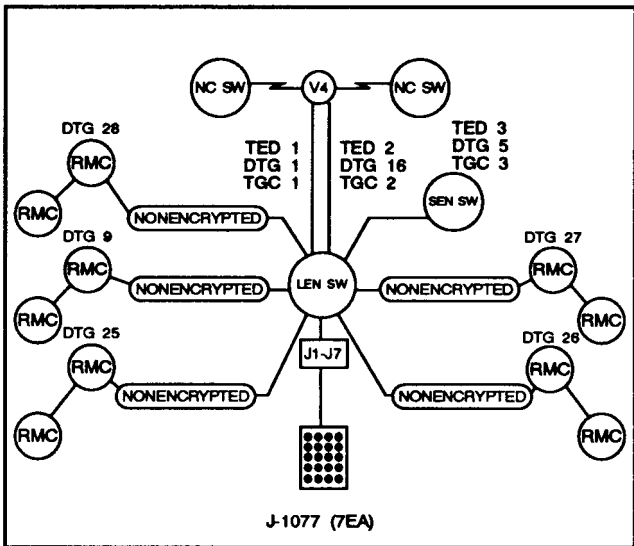

Figure 3-21. LEN switch DTG/TGC standard database.

Table 3-5. COMSEC keys initialization chart.

	KEY	TYPE	WHERE USED	DISTRIBUTION	DESCRIPTION
SUBSCRIBER	M	TEK	KY-88 RT-1539	CORPS COMMON	USED IN KY-88 FOR INITIAL AFFILIATION. USED IN MOBILE COMSEC UNIT (MCU)
	X	TEK	KY-88 NS/LENS RT-1539	CORPS COMMON	ENCRYPTS CALLS ASSOCIATED WITH MSRT OR DSVT USERS. AUTOMATICALLY REPLACES M KEY UPON SUBSCRIBER AFFILIATION.
	U1-23	KEK	KY-88 NS/LENS	ONE PER SUBSCRIBER DETERMINED BY PROFILE	USED TO SUPPORT TS/SCI USERS TO THE TYC-39 MESSAGE SWITCH.
	U24 AND 25	KEK	KY-88 NS/LENS	ONE PER SUBSCRIBER DETERMINED BY PROFILE	USED TO SUPPORT TS/SCI USERS TO THE TYC-39 MESSAGE SWITCH.
	V	TEK	KY-88	UNIQUE PER CALL	GENERATED BY KG-82/KG-112 ENCRYPTS INDIVIDUAL SECURE CALLS.
	S	TEK	KY-88	SPECIAL USE	GENERATED AND USED BY OTHERS TO RAISE ENCRYPTION LEVEL TO TS/SCI (USUALLY MILITARY INTELLIGENCE #4).
TRUNK	TG	TEK	KG-84/A	CORPS/ DIVISION UNIQUE TO GATEWAYS	USED TO ESTABLISH GATEWAY TRUNKS (BETWEEN CORPS OR FROM CORPS TO EAC) UPDATED BY LINK MASTER.
	TI	TEK	KG-84/A	CORPS COMMON	USED BY ALL NS/LENS WITHIN THE CORPS TO INITIALLY SYNCHRONIZE TENDs BETWEEN NCS OR LENS. ALLOWING BULK TRANSFER OF KEYS.
	TN	TEK	KG-84/A	PAIR WISE UNIQUE	USED TO ENCRYPT TRUNKS FOR SENs. UPDATED BY LINK MASTER.
	TE	TEK	KG-84/A	ONE PERSON NSG (SEN)	USED TO ENCRYPT TRUNKS FOR SENs. UPDATED BY LINK MASTER.
	TEc	TEK	KG-84/A	ONE CORPS COMMON FOR ALL RAUs	USED TO ENCRYPT TRUNKS FOR RAUs. UPDATED BY LINK MASTER.
ORDERWIRE	N	TEK	KY-57	CORPS COMMON	USED TO ENCRYPT ORDERWIRE TRAFFIC BETWEEN ALL MISE ASSEMBLIES WITH ORDERWIRE CAPABILITY.
	K	KEK	KY-57	CORPS COMMON	USED TO ENCRYPT COMSEC KEYS FOR OTAR TRANSMISSION.
SWITCH	CIRK	KEK	NS/LEN	CORPS COMMON	USED TO ENCRYPT THE TRANSFER OF THE PER-CALL (M) KEY BETWEEN NS/LENS.
	AIRK	KEK	NS	AS NEEDED	PROVIDES SAME ENCRYPTION AS CIRK KEY. ONLY IT IS USED BETWEEN GATEWAY SWITCHES.
	BTc	KEK	NS/LEN	CORPS COMMON	USED TO ENCRYPT THE BULK TRANSFER OF INDIVIDUAL OR ENTIRE KEY SETS BETWEEN AKDCs.
	MSRV	KEK	NS TYC-39	MESSAGE SWITCH REKEY (SPECIAL USE)	USED TO ENCRYPT THE PER-CALL KEY TO THE TYC-39 MESSAGE SWITCH.
	MSNV	TEK	NS TYC-39	MESSAGE SWITCH NET KEY (SPECIAL USE)	USED TO ENCRYPT THE SYNCHRONIZATION SIGNALING BETWEEN MSE AND THE TYC-39 MESSAGE SWITCH.

**MSE TACTICAL PACKET NETWORK**

**General.** The MSE TPN performs data distribution. The TPN uses a few MSE trunks exclusively for data distribution using the packet switch. Packet switching divides data transmissions into small “packets” and routes them along the most efficient path to their destination. The receiving packet switch reassembles the data and sends it to its destination computer. The result is an efficient method of data distribution that has almost no effect on voice traffic.

**Implementation.** The TPN is implemented with AN/TYC-20 packet switches in the NC, LEN, SEN, and SCC-2 switch assemblages. (See Figure 3-22.) In the SCC-2's packet network management center (PNMC), the system planner manages the network. AN/TYC-19 gateways at NC switches provide connectivity between other data networks, such as the EAC TPN. Data is transferred at 64 kbps for NC to NC and NC to LEN connections and at 16 kbps for NC to SEN and LEN to SEN connections.

**User Access.** Users who wish to gain access to the TPN must have the following:

**Physical Interface.** The signal entry panels on the SEN and LEN switches have connectors for RG-58 Ethernet ThinLan coaxial cable. LANs inside the CP are connected to this cable. There are two connectors on a SEN switch, four on a LEN switch, and one on an NC switch.

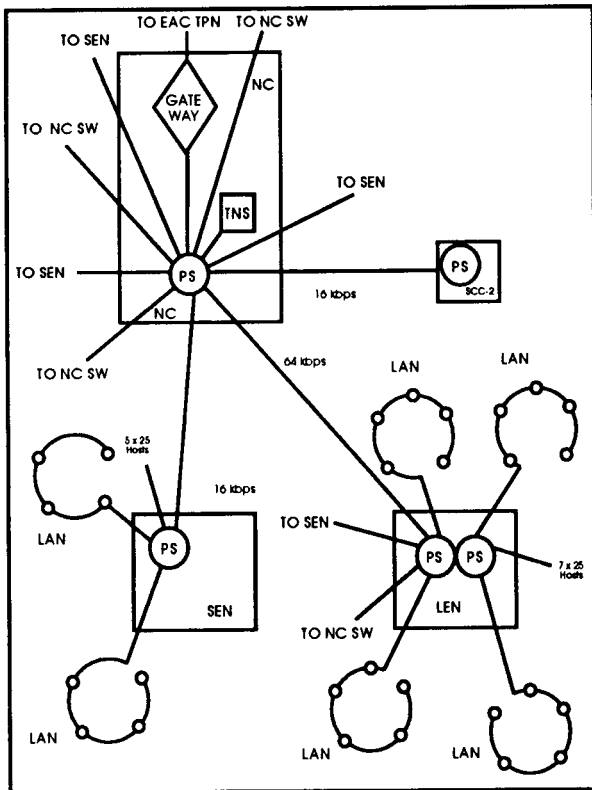

Figure 3-22. The TPN system.

The length of the coaxial cable cannot exceed 185 meters (600 feet). In addition, host computers with X.25 conditioned diphase compatibility connect to a J-1077 using WF-16 field wire. The J-1077 connects to the packet switch. The SEN has the capability to support 58 LAN subscribers. See Figure 3-23.

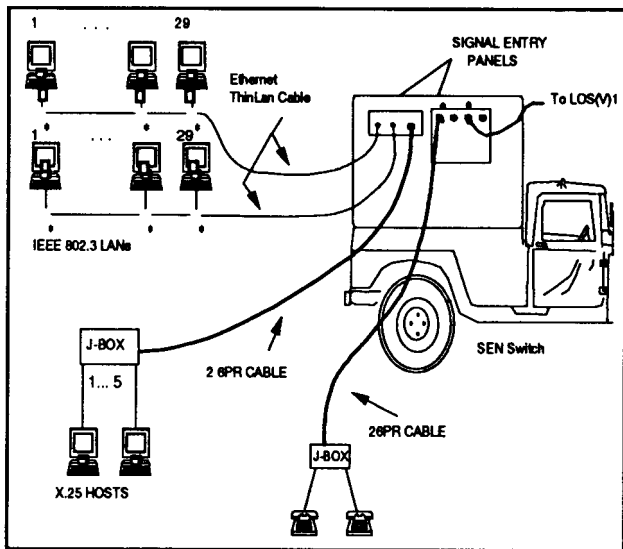

Figure 3-23. TPN host connectivity at a SEN.

## FM 11-43

**Protocol and Software.** In addition to being physically connected to the TPN, the user's computer system (or host) must be able to interface with the TPN. To do this, the system must support DOD standard protocols for functions like mail and file transfer. These are the same protocols used by the defense data network (DDN). The software should support a tactical name server (TNS). This is necessary due to the high mobility of computers in the tactical arena. Once a host sets up at a new location, it must "affiliate" much like the MSE voice users do. The TNSs, found at NCs, keep track of each host's location in the area network.

**Addresses.** Every mobile host is assigned a unique, deducible name. For example, the G3, 1st Cavalry Division, III Corps using one MCS host would have the following address:

G3-1CAVM1-G3-1CAV.3C.ARMY.MIL\*

\* A standard Internet Protocol (IP) naming scheme has not been approved as of March 1995.

**QUICK LAN TROUBLESHOOTING**

Ensure that the IP address is correct. If not, provide the user with the correct IP address and direct the subscriber to return to normal operation.

Ensure the connection from the subscriber to the SEN or LEN is good (either direct connection via the J-Box to the signal data connector (SDC), or LAN connection through the integral gateway (IGW) to the AN/TYC-20(V)2).

Ensure the operator has made a visual inspection of the AN/TYC-20(V)2 front panel for failure indicators. The indicators are: light emitting diode's (LED's) 19 plus the appropriate port LED's, 0-5, Lit for X.25 hosts and or LED 16 plus LED 8 Lit for LAN hosts during SCAN cycle.

If the AN/TYC-20(V)2 indicates failure, the switch operator will begin packet switch troubleshooting in accordance with the appropriate technical manual.

If the Echo Test of the terminal fails instruct the user to begin appropriate troubleshooting according to the manual for the devices being used to access the PSN.



### **MSE TROUBLESHOOTING**

LOS radio links connect MSE nodes. Each link is vital to the network while some links are more important than others. MSE network planners, coordinating with the corps and division G3 staffs, determine the priority for initializing and restoring links.

The LOS and NC switch equipment operators establish, operate, and maintain the links. This ensures the system is working properly. When a system fails or operations begin to degrade, the NMF operator notifies the SCC-2 of the situation. They also initiate troubleshooting procedures to find the cause of the problem. The troubleshooting process is a coordinated effort between MSE elements.

Every link in the MSE system has a label. The first half of the designator is the master link; the second half is the slave. The master terminal operator reports all link failure to the SCC-2. Failure reports are sent in message report format if possible. If not, the reports are sent to the SCC-2 by CNR, MSRT, DNVT, or courier. The SCC-2 must be informed of link failures as soon as possible. This allows the SCC-2 to react quickly to the failure.

Troubleshooting procedures are coordinated between the master and slave ends of the link using various means. The preferred means is by the secure DVOW.

If the DVOW is not available, it may still be possible to use the engineering orderwire (EOW). Exercise caution when using the EOW, because it is not secure, CNR is another means to troubleshoot.

When a link outage occurs, it generates an error message at the NC or LEN switch. The switch operator must contact each assemblage within the failed link. Each assemblage operator provides assistance for loop back tests until the outage can be isolated and corrected. Particular caution must be taken when doing MDTG loop back tests (between an LOS(V)3 radio and the NC switch). MDTG loop back testing disrupts all communications on the tested MDTG.

Maintain the trunk status of the links when troubleshooting using a status chart. See Figure 3-24.

There are five loopbacks used inside the LOSS for link initialization. All five loops are available in each LOS type.

- **6-1-6 loop:**
  - Loopback from baseband units to associated LOS equipment.
  - A good indication is L1 on the radio.
- **6-2-6 loop:**
  - Loops data from the terminating assemblage back to the terminating assemblage (SEN/RAU/LEN).

## FM 11-43

- Good indications are **L2\_** in the radio, and the TED in the terminating assemblage in resync and full operate condition.

- The operator must disconnect the antenna coaxial cable.

- **6-3-6 loop:**

- Disable signal from the baseband to the assemblage.

- A test pattern is generated on the transmit side of the baseband, which is looped back in the diplexer of the RF head. An error detector on the receive side of the baseband compares the receive pattern with the original.

- A good indication is **L3\_** on the radio

- The operator must disconnect the antenna coaxial cable.

- **Radio patch loopback:**

- Loops data incoming from the distant end of a radio link back to the originating point.

- DVOW communications is nonfunctional using this loop.

• **6-4-6 and 6-5-6 loops:**

– 6-4-6 loop disables the signal from the baseband to the assemblage. A test pattern is generated in the baseband and transmitted to the distant end.

– 6-5-6 loop is used with the 6-4-6 loop. It loops incoming data from the 6-4-6 loopback to the originating LOS, where it is compared to the original signal.

– A good reading at the 6-4-6 end would be **L4\_ \_E5** or **L4\_ \_E6**. If there were a fault, it would be indicated as follows: **4F4**, as an example.

– A good reading at the 6-5-6 end would be **L5\_ \_E5** or **L6\_ \_E6**. If there were a fault, it would be indicated as follows: **5F4**, as an example.

– The readings are a measure of the bit error rate on the RF link.

– Each LOS in the link would perform a 6-4-6 loop to a 6-5-6, then reverse the loops.

***See TM 11-6800-216-10-4 for complete system and link troubleshooting and fault isolation procedures.***

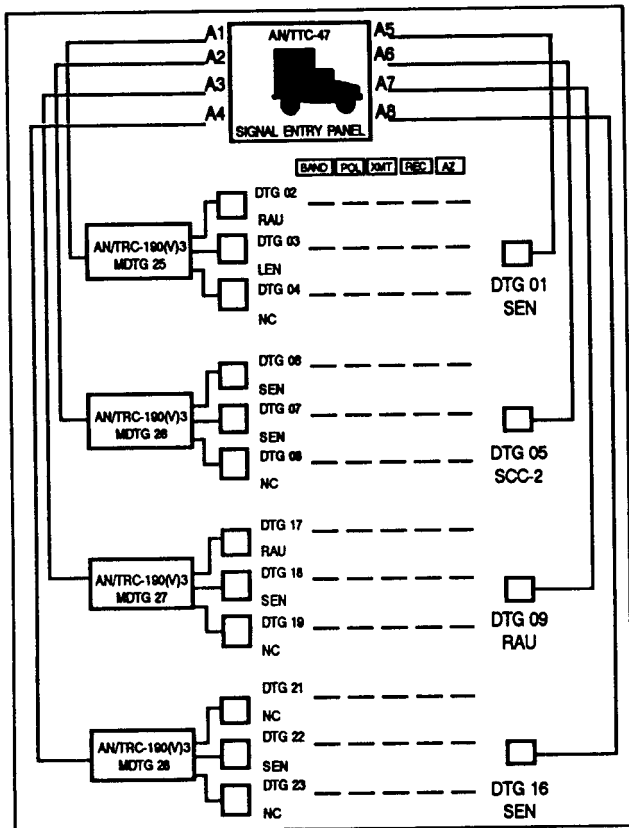

Figure 3-24. NC switch trunk status diagram.

### **3-3. The TRI-TAC System**

EAC use the TRI-TAC system as the primary area communications system. Similar to MSE, the TRI-TAC network forms a communications grid of area nodes which cover the area of operations. The area nodes normally interconnect by LOS SHF links up to 40 kilometers apart. Users gain access to the network at many extension nodes, which tie into the area nodes through LOS UHF links. The use of relay assemblages can increase the distance between nodes. TACSAT and TROPO links can further extend the range between nodes. See Figure 3-25.

The TRI-TAC network is a digital, large volume, circuit switched system and has analog to digital converting capability. This allows the EAC customers to use the same DSVTs and DNVTs as corps and below subscribers. It is designed around the AN/TTC-39D area node switch. The AN/TTC-39D, an upgraded switch, provides packet switching, flood search routing, and subscriber affiliation for the TRI-TAC network.

In addition to voice communications, TRI-TAC can switch message traffic with the tactical message switch, AN/TYC-39. The AN/TYC-39D is an automatic, store-and-forward message switch.

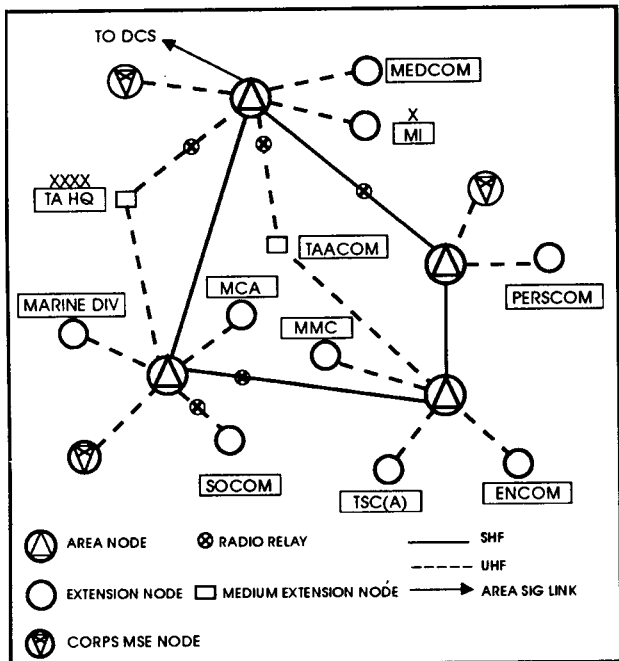

Figure 3-25. TRI-TAC area communications system.

**AREA NODE**

**Function.** The area node primarily consists of an AN/TTC-39D switch and its associated multichannel link assemblages. Area nodes serve as central access points for the medium and small extension nodes. Each area node operates as an automatic switching point that receives traffic and routes it to other nodes. Node management is performed from a communications system control element (CSCE), AN/TYQ-31. See Figure 3-26.

**Connectivity.** A standard node configuration terminates four SHF links to other area nodes, four UHF links to small extension nodes, and two UHF links to medium extension nodes. These connect by an SHF radio or cable link to a radio terminal assemblage, AN/TRC-175. It passes the DTGs to the AN/TTC-39D switch which can handle 712 circuits and can switch both analog and digital trunks. The node connects to multichannel TACSAT/TROPO systems and NATO subscribers using the standard NATO interface device.



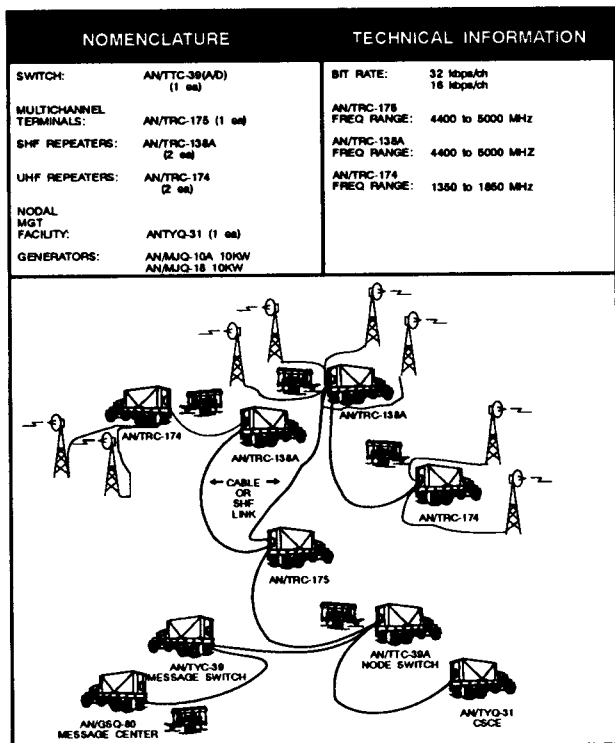

Figure 3-26. Typical TRI-TAC area node.

**EXTENSION NODE**

**Function.** The TRI-TAC extension nodes consist of an AN/TTC-48A switch and a single multichannel link. They service smaller units requiring access to the theater area communications system. The extension node provides automatic circuit switching, terminations for up to 41 subscribers, and has an NRI for CNR users. RAU coverage gives users with MSRTs access to the theater area communications system. See Figure 3-27.

**Interconnectivity.** The SEN connects with the area node through a single UHF multichannel link to a radio terminal assemblage, AN/TRC-173. The MSE SEN switch, AN/TTC-48A, performs circuit switching and connects to the J-1077s. Users install field wire from their telephones to the J-1077s. Users can also install telephones by using RMCs. They connect to the AN/TRC-173's group modem (GM) by cable.

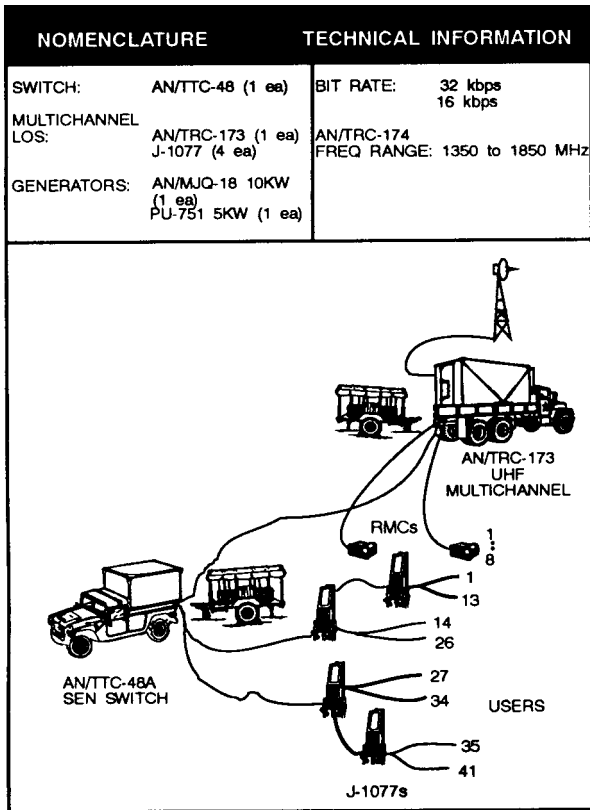

Figure 3-27. Typical TRI-TAC extension node.



**Function.** The TRI-TAC headquarters medium extension node consists of an AN/TTC-46 switch, an AN/TRC-174, a message center, and an operations van. The medium extension node services larger units requiring access to the theater area communications system. See Figure 3-28.

**Interconnectivity.** The medium extension node is dual homed with the AN/TRC-174 providing two LOS UHF links to area nodes. Subscribers connect to the switch through J-1077s and RMCs. The switch supports NATO interfaces.

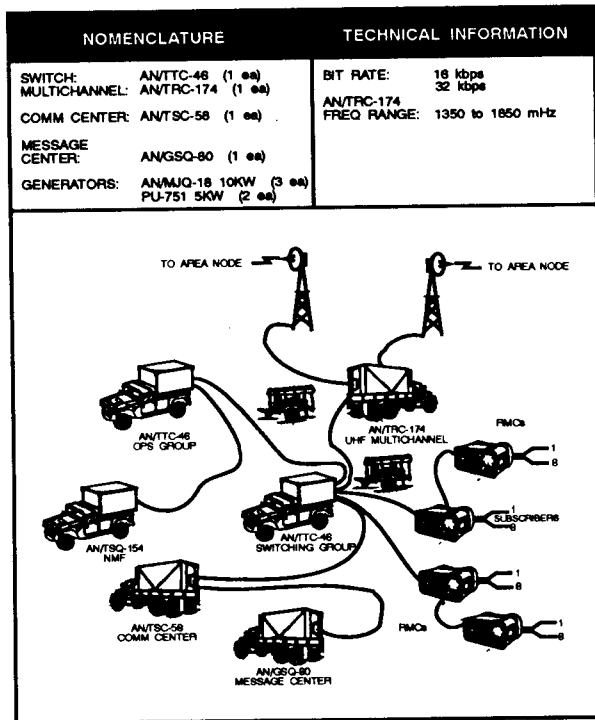

Figure 3-28. Typical TRI-TAC medium extension node.

### 3-4. Subscriber Terminal Equipment

The supporting signal battalion provides the users access to the ACUS. The users provide their own terminal equipment and ensure it is functioning properly. The maneuver signal officer ensures equipment maintenance is scheduled and performed.

A sampling of this equipment includes—

- DNVT, TA-1035/U or TA-1042A/U.
- DSVT, TSEC/KY-68.
- MSRT, AN/VRC-97.
- Lightweight digital facsimile (LDF), AN/UXC-7/7A.
- CT, AN/UGC-144.

**DNVT, TA-1035/U or TA-1042A/U.** This is a 4-wire nonsecure telephone terminal that transmits and receives full duplex, conditioned diphase, digitized voice and loop signaling information. The DNVT (TA-1035/U) is the primary nonsecure voice/data terminal device used by static subscribers to access the MSE/TRI-TAC system via a SEN, usually collocated with a CP. The TA-1042A/G operates at 16 or 32 kbps. Most Army communications networks require terminal devices to be set at 16 kbps. The 32 kbps setting may be used to interface with joint/TRI-TAC switches (always verify the settings used with the local switch). The local switch provides power for the DNVT therefore no batteries are needed. The local switch also provides a nonsecure warning tone for the DSVT user if the user initiates the call to a DNVT; however, the tone stops as soon as the DNVT user answers the call. The user connects the DNVT by installing WF-16 field wire from the

## FM 11-43

DNVT to a J-1077. The signal battalion's SEN team provides the J-1077. The user installs the field wire up to 4 kilometers. See Figure 3-29.

### Technical Features.

- Input power voltage: +24 to +56 VDC.
- Input power: 300 milliwatts on-hook  
1.5 watts off-hook.
- Weight: 5 pounds 12 ounces.
- Compatible with: AN/UXC-7A, AN/UGC-144, and DSVT.

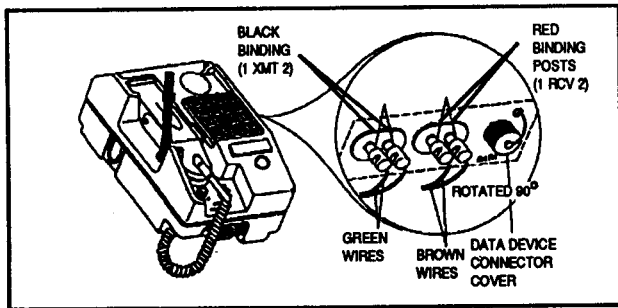

*Figure 3-29. DNVT, TA-1035/U and field wire connections.*

**DSVT, TSEC/KY-68.** This is a tactical telephone terminal with a built-in encryption/decryption module for secure traffic. It is a full-duplex voice and data interface terminal. It digitizes voice signals and transmits at 16 or 32 kbps. Most Army communications networks require terminal devices to be set at 16 kbps. The 32 kbps setting may be used to interface with joint/TRI-TAC switches (always verify the settings used with the local switch). Although used primarily for secure communications, the DSVT is interoperable with the DNVT. The traffic in this mode, in a protective environment, is secure at least at the SECRET level. The local switch provides the DSVT user with a warning tone when communicating with a nonsecure terminal; however, the tone stops as soon as the DNVT user picks up the handset. For data communications, the DSVT is equipped with a data port for encryption with various data devices such as MCS, tactical facsimile, and special circuits. See Figure 3-30.

The DSVT (TSEC/KY-68) is normally found in three configuration: static (wire), MSRT (mobile), and as stand-alone (static with the RT-1539). See Figures 3-31 and 3-32. Generally, DSVTs (in an MSRT configuration) are found with the commander, the S3 section, and the XO. It is a commander's prerogative on the actual locations of the DSVTs.

#### **Technical Features.**

- Input power voltage: +21 to +56 VDC.
- Circuit Protection: DC-4 fuses 1/2 ampere.
- Weight: 14 pounds.



## FM 11-43

- Compatible with: AN/UXC-7, AN/UXC-7A, AN/UGC-144, and DNVT.

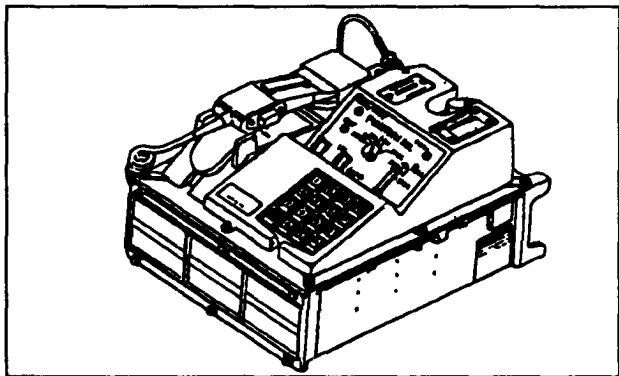

*Figure 3-30. DSVT, TSEC/KY-90.*

**MSRT, ANNRC-97.** The MSRT provides secure, full-duplex voice communications to the user throughout the tactical area of operations. It consists of a VHF radio and a DSVT. The MSRT automatically selects random channels for each call and chooses the lowest effective RF transmit level. The radio transmits in the low band and receives in the high band and interfaces at 16 kbps to the DSVT which provides secure, discrete addressability. The MSRT can be installed in a vehicular configuration (MX-2564/AN/VRC-97)

or in a stand-alone mode (MX-2565/AN/VRC-97) when used with a power supply such as a PP-2953. See Figures 3-31, 3-32, and 3-33.

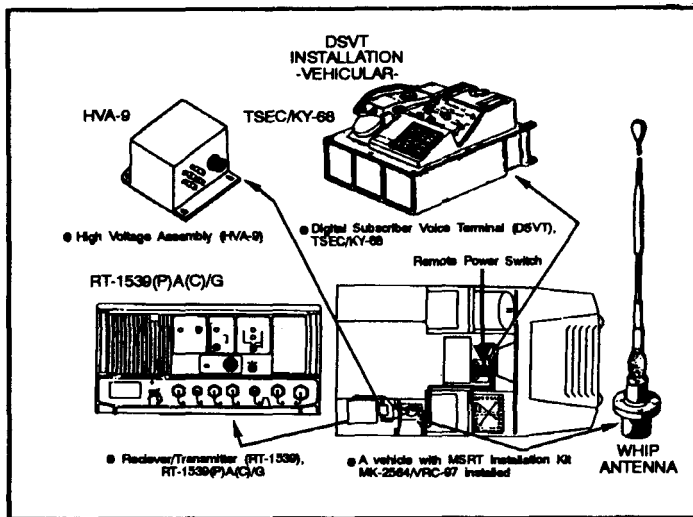

*Figure 3-31. Vehicle mounted (MK-2564/AN/VRC-97) MSRT.*

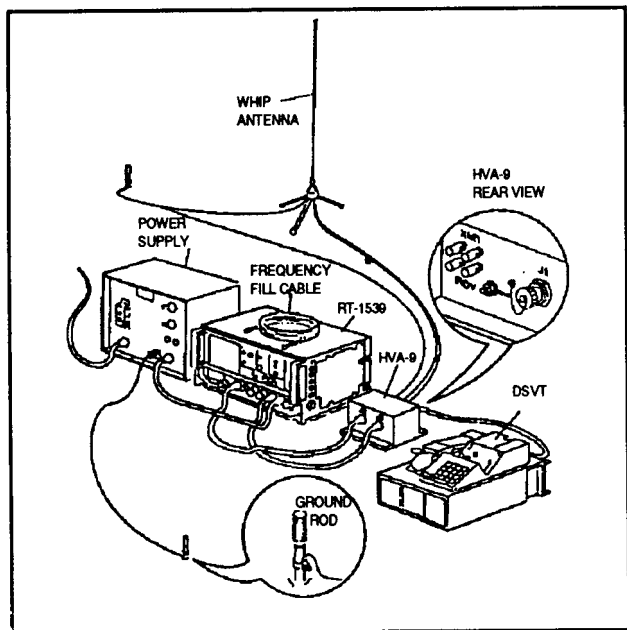

*Figure 3-32. Stand-alone kit (MK-2565/AN/VRC-97) with MSRT.*

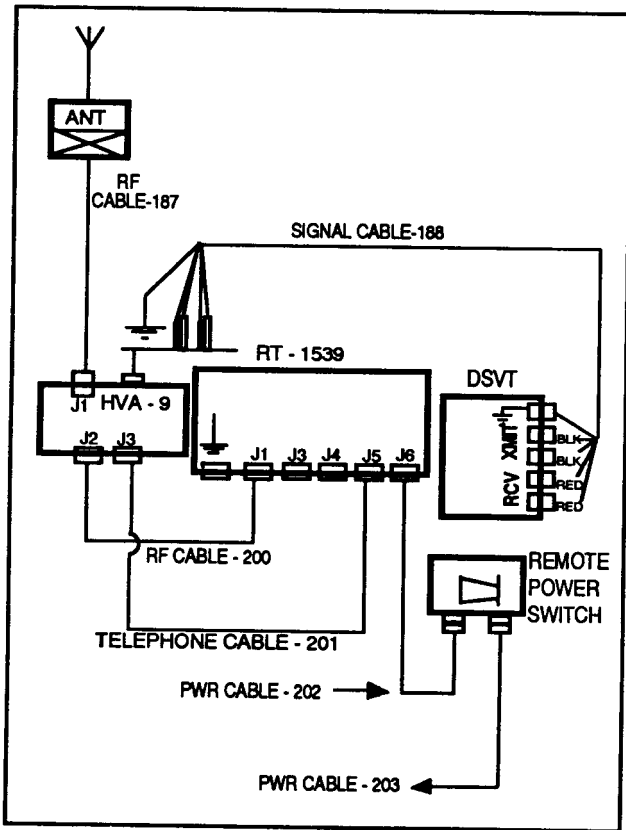

Figure 3-33. MSRT wiring diagram.

## FM 11-43

### Technical Features.

- Input power voltage: +21 to +33 VDC.
- Power output RF output, 14 to 18 watts.
- Circuit protection: one 16-ampere power fuse; four 0.25 ampere line fuses.
- Frequency range 30 to 88 MHz.
- Transmitting range: 15 kilometers.

The MSRT consists of the following components:

- **Receiver-Transmitter (RT), RT-1539.** This is a very high frequency (VHF)-FM transceiver which is the heart of the MSRT. The RT-1539 is the radio used in the RAU. The radio operates in a full-duplex mode with a high and low frequency band for transmit and receive channels. In the RAU, the radio transmits in the high band and receives in the low band. This procedure reverses when the radio is used in the MSRT configuration. The RT-1539's power requirements are +21 to +33 VDC. Its levels of HF power are as follows: N0, 16W nominal; N1, 3W nominal; N2, 0.5W nominal. The continental United States (CONUS) mode is 30 to 35 MHz and 40 to 50 MHz. Outside continental United States (OCONUS) mode is 30 to 51 MHz and 59 to 88 MHz. Its radio planning range is 15 kilometers.

- **DSVT, TSEC/KY-68.** It makes up the telephone portion of the MSRT. It functions the same as described in the previous section. The DSVT can be remotored up to one kilometer or 1/2 mile.

- **VHF Antenna, AS-3885.** It is a fiberglass, vehicle spring-mounted whip antenna. It is insulated to avoid electrical shock. During transportation, the AS-3885 is tied down to avoid damage.

- **High Voltage Antenna (HVA), HVA-9.** It provides high altitude electromagnetic pulse (HAEMP) protection for the MSRT and 4-wire connectivity when remotored.

- **Remote Power Switch.** It is part of the vehicle kit. The two-position toggle switch controls power to the RT-1539 when mounted in specified Army vehicles. The remote power switch provides the power receptacle for the AN/UXC-7/7A.

**MSRT and DSVT AFFILIATION**

**PROCEDURES**

**MSRT Affiliation RT-1539**

(1) Perform all the preoperational adjustments and settings in accordance with TM 11-5820-1021-10.

(2) Turn on the radio.

(3) Load the M key - Connect the KYK-13 to the fill connector on the front panel of the RT-1539, ensuring that the KYK-13 selector (1-6) is in the position containing the M variable and the selector switch is in the ON position. Raise the Fill/Zero switch on the RT-1539 four times in rapid succession. **DO NOT RAISE MORE THAN FOUR TIMES.** If the crypto alarm light goes off, the fill was successful. If the light remains lit, remove the KYK-13 and zero the RT-1539 then attempt to reload the M variable. See Figure 3-34.

(4) Install the DSVT.

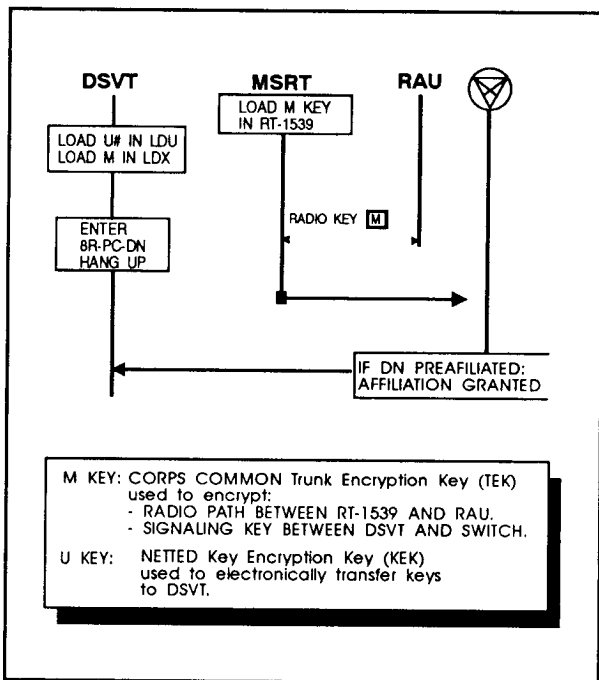

Figure 3-34. MSRT affiliation process.



## **FM 11-43**

(5) Verify frequency plan by dialing 8 I xx R where xx is the plan number the subscriber is using. If the light comes on (you will hear either a dial or error tone), then plan xx is in reserve; if the light flashes (you will hear either a dial or error tone), then plan xx is active; if no light appears (you will hear a busy tone), then there is no plan loaded in the MSRT.

(6) Cable download—if plan xx is not loaded in the MSRT and perform the following procedures:

a. Connect frequency fill cable P2 connector to the REMOTE CONTROL CONNECTOR on the RT-1539 which is to receive the frequency plan. Connect the RT-1539 which already has the frequency plan loaded.

b. Pick up the handset on the MSRT needing the frequency plan. Unlock the DEPRESS/LOCK cradle hook switch and turn counterclockwise to the up position.

c. Using the key pad of the DSVT, dial 8CFR 8FFR.

d. You will hear a low frequency tone on the hand set and the Loaded Frequency Plan light on the RT-1539 will flash. Once this tone ceases and the Loaded Frequency Plan light goes solid, you will hear an error tone. Hangup the hand set.

e. Disconnect the fill cable from both radios.

f. Verify the frequency plan by following instructions outlined in paragraph (5) above.

**DSVT Affiliation**

(1) Place the function selector switch on the DSVT in the DSBL position. Ensure that the DSVT has been zeroized by pulling up on the VAR/STOP switch and moving it to the ZERO position and then releasing it back to the center position.

(2) Place the function selector switch on the DSVT in the LDU position. Turn on the KYK-13. Connect the KYK-13 to the DSVT and place the KYK-13 function selector switch in the position containing the U variable.

(3) Press and hold the VAR/STOP switch to the load position. A tone should be heard. Release the switch to the center position, a second tone should be heard. If the two tones were heard, the load was successful.

(4) While the KYK-13 is still connected to the DSVT, place the switch of the KYK-13 to the position containing the U variable. Place the DSVT selector switch to the LDX position. Press and hold the VAR/STOP switch to the load position. A tone should be heard. Release the switch to the center position. Another tone should be heard. If the two tones are not heard, the load was not successful. If the load was successful, disconnect the KYK-13.

## FM 11-43

(5) Load the personal code and directory number. Remove the handset of the DSVT from the cradle. You should hear an error tone. Using the key pad of the DSVT, dial 8R + the three-digit personal code + the seven-digit directory number. Dial tone should be returned. See Table 3-6.

*Table 3-6. MSRT troubleshooting chart.*

SYMPTOM	PROBABLE CAUSE	CORRECTIVE ACTION
*DSVT is "dead." If connected directly to NC switch, it is marked out of service. No sync attempt, no drop-off.	U key mismatch.	Ensure correct U key is being used.  NOTE: U key must match user's terminal profile
Error tone on DSVT, CRYPTO ALARM, TRAFFIC/SCANNING and AFFILIATION lights flashing.	RT-1539 M key mismatch.	Reset RT-1539 by turning the OFF/BLACKOUT/ON switch to OFF, then to ON, if M KEY mismatched occurs again, reload M key in RT-1539.
TRAFFIC/SCANNING indicator flashes then becomes solid while DN is being confirmed. If DN is not confirmed, then the TRAFFIC/SCANNING indicator goes from solid to flashing.	DN refused during affiliation.	Ensure correct DN is used. Dial *0* for operator assistance.
After 2 min. FREQ PLAN indicator starts to flash. AFFILIATION indicator is off. TRAFFIC/SCANNING indicator is flashing. Error tone on DSVT.	Unable to find RAU marker.	Reset RT-1539 by turning the OFF/BLACKOUT/ON switch to OFF, then to ON. Attempt to affiliate. If unsuccessful: RAU may be down, or you may be out of RAU range.
*NOTE: The most common error is to load the incorrect key into a terminal device. This could occur when users improperly share keys (KYK-13). To prevent this, units should develop a key distribution plan per SOP.		

Table 3-6. MSRT troubleshooting chart (cont).

SYMPTOM	PROBABLE CAUSE	CORRECTIVE ACTION
Loaded DIR PLAN indicator flashes. Error tone on DSVT.	Wrong PC entered (only after a successful disaffiliation from the system).	Verify PC and attempt to reaffiliate. (After 4 attempts, you will be blacklisted.) If indicator is still flashing after 3 attempts, dial *0* for operator.
Loaded DIR NO AFFILIATION and TRAFFIC/SCANNING indicators are flashing. Error tone on DSVT.	Blacklisted.	Refer to the phone directory for procedures. Contact BSO.
AFFILIATION indicator flashing. Error tone on DSVT.	RAU saturation has occurred.	Only high precedence calls (immediate and above) may be processed. Unless you have a high precedence call, wait until indicator stops flashing, then make call.
ALARM indicator is flashing. DSVT rings.	Low DC power.	Turn RT-1539 OFF/BLACKOUT/ON switch to OFF, start vehicle. Turn RT-1539 OFF/BLACKOUT/ON switch to ON. If vehicle takes longer than 20 seconds to start, you must reaffiliate your MSRT.
ALARM indicator is flashing. DSVT rings.	Problem external to RT-1539.	Check cable connections, antenna, and DSVT connections. If all connections are correct, call maintenance personnel.
Voice quality is poor or starts to fade out.	Poor voice communications.	Go on hook, then off hook and redial subscriber, or go on hook, stop vehicle, turn REMOTE POWER switch or turn RT-1539 OFF/BLACKOUT/ON switch to OFF. Leave RT-1539 on, reaffiliate the MSRT, and place the call again.

## **FM 11-43**

**LDF, AN/UXC-7/7A.** This is a tactical facsimile that electronically transmits data from one LDF to another. The LDF is ruggedized and has a universal mount which allows installation in tactical vehicles. It transfers data over radio, common-user telephone systems, or digital equipment. The LDF connects to the MSE network through the data ports on DSVTs and DNVTs. The LDF can transmit maps, photographs, line drawings, and printed or handwritten messages. Because it uses carbon paper, no special toner is needed.

The LDF has two separate modes of operation: Mode A and Mode B. The appropriate transmission medium (CNR, MSE, or TRI-TAC) must be considered when determining the mode of operation.

In Mode A, images are scanned and transmitted from one machine to another machine that receives and prints as the transmitted information arrives. This mode requires more transmission time than Mode B.

When Mode B is selected, the LDF becomes much more versatile. Each LDF has an image memory, a transmit memory, a receive memory, and supporting electronic functions which are now activated. Pressing the MEMORY LOAD switch causes processed scanner data to be entered into the image memory from where it can then be appropriately formatted for rapid transmission (called burst operation) from the transmit memory into the receiving LDF's receive memory. The data can now be printed out at

the convenience of the receiving operator. An important advantage of Mode B operation is that significantly less time is required on the communications link.

The AN/UXC-7/7A can store images in memory and reproduce or send them at a later time. See Figures 3-35, 3-36, 3-37, and 3-38. Table 3-7 gives an LDF troubleshooting chart.

**Technical Features.**

- Input power voltage: +22 to +32 VDC; 115/230 VAC at 47 to 470 Hz.
- Power consumption
  - Standby: 50 watts.
  - Operating: 100 watts.
- Weight: 54 pounds
- Transmission Speed:
  - Mode A - Analog: 2 to 6 minutes for an 11-inch page.
  - Mode B - Digital: 7 to 15 seconds for an 11-inch page.

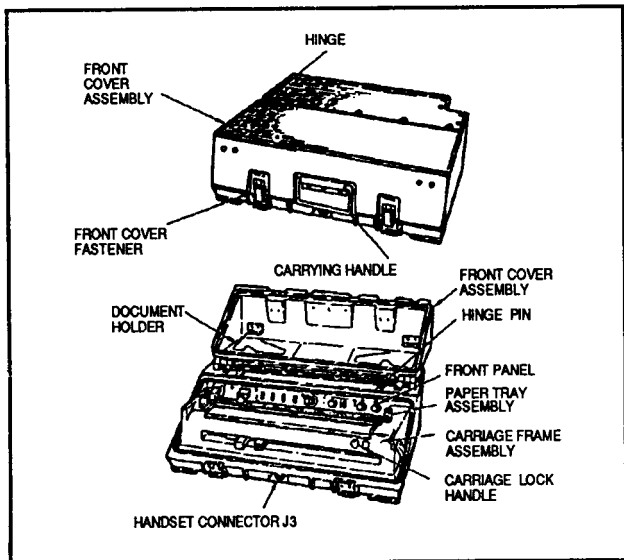

Figure 3-35. LDF, AN/UXC-7/7A.

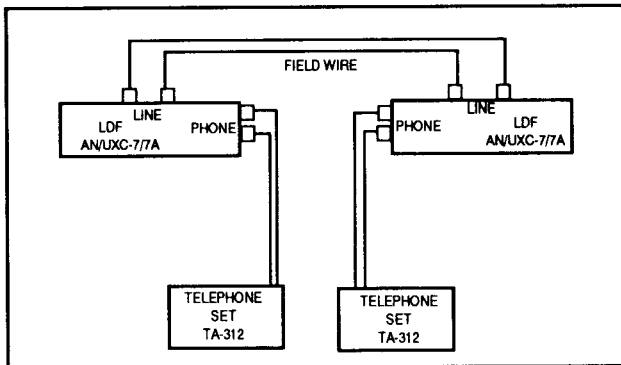

Figure 3-36. Phone line interface to LDF.

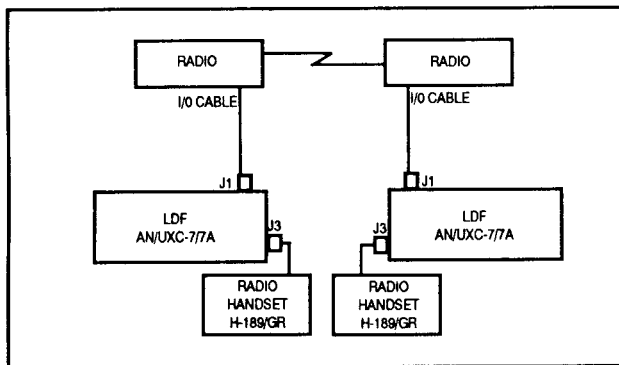

Figure 3-37. Radio interface to LDF.



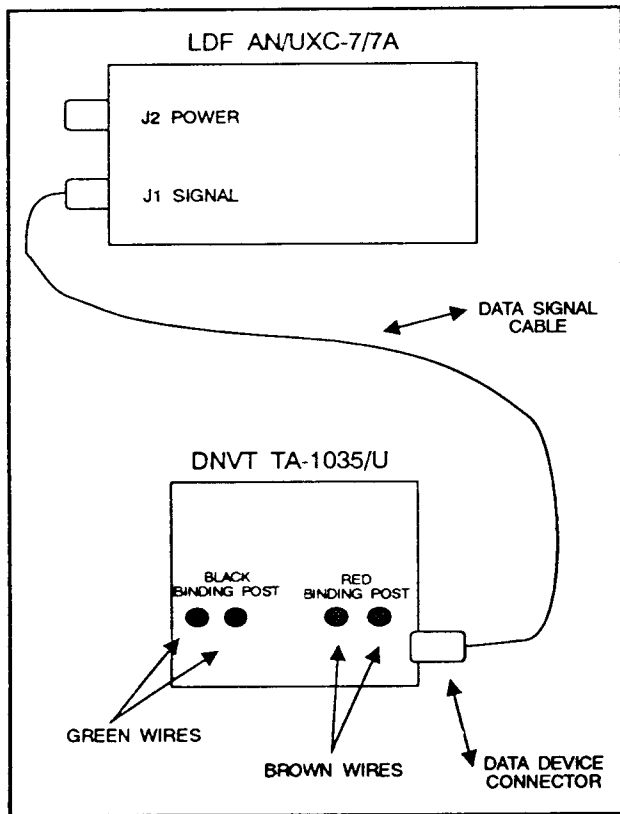

Figure 3-38. MSE telephone interface to LDF.

Table 3-7. LDF troubleshooting chart.

SYMPTOM	PROBABLE CAUSE	CORRECTIVE ACTION
Output copy smeared.	Print stylus jammed.	Clean stylus pivot assembly using paint brush NSN 8020-00-263-3873.
Input and output copy scratched or marred.	Document pads dirty.	Clean document pads using typewriter brush, NSN 7510-00-550-8446.
Vertical plane of transmitted image tilted on output copy.	Improperly loaded input or output copy.	Reload input and output copies.
Voice transmission continuously keyed when used in voice transmit mode.	Defective handset connection.	Disconnect and reconnect handset. If problem continues, replace handset.
Error lamp does not flash at power on.	Loss of power.	Check power indicator and recycle PUSH FOR ON power switch.
Error lamp stays on.	Memory BIT failure.	Recycle PUSH FOR ON power switch.
Will not produce shades of gray.	Improper switch settings.	Check switch settings to ensure GRAY/B-W. Transmit switch is set to GRAY.
Will not receive message.	Margin stops are together.	Separate margin stops.

**FACSIMILE OPERATION**

The following is a checklist for facsimile operation, The operator must--

- Ensure that the DNVT/DSVT is affiliated.
- Ensure that the facsimile is properly connected to the DNVT/DSVT.
- Preset the switches on the facsimile,
  - .. Unlock the carriage lock handle
  - .. Set the MODE switch to COMP FEC.
  - .. Set the ANLG/DIGITAL switch to DIGITAL.
  - .. Set the HI RES LO SP/HI SP LO RES switch as needed. (This setting is determined by the document being transmitted.)
  - .. Set the GRAY/B/W switch as needed.
  - .. Set the NATO switch to the LDF position.
- Turn on the power (push IN on POWER switch).
- Press the PAPER RELEASE lever and insert paper to transmit slot.
- Place the paper text side up lengthwise into facsimile.
- Set the margins.
- Press the MEMORY LOAD button.
- Remove the paper when the scan is finished.
- Verify that the MEMORY LOAD indicator is lit.
  - .. Insert the copy set page into the facsimile to make a copy. (If using carbon, place it on top of the blank page and insert both.)
  - .. Set the margins.
  - .. Press the SELF TEST switch.

- Contact the receiving station over the DNVT/DSVT to send the copy.
- Ensure that the distant-end operator has the switches set in the same mode of operation as the sending machine.
- Instruct the distant-end operator to press the RECEIVE button.
- Press the TRANSMIT button. (The distant-end operator prints the message after it is received.)

**CT, AN/UGC-144.** This is a digital communications terminal that provides single-subscriber operation. When in a network, the unit has a full-duplex asynchronous communications capability. It has the ability to access the automatic digital network (AUTODIN) and can monitor narrative message traffic in the U (unclassified), R (routine), and Y (emergency command precedence, usually seen as TOP SECRET/sensitive compartmented information (TS/SCI)) communities. The CT is a medium-speed device that includes interface data, power supply, and control mechanisms. See Figure 3-39.

The CT is typically found in military intelligence units and division, corps, and theater headquarters. Figure 3-40 shows a configuration of CT communications via MSE.

**Technical Features:****TERMINAL:**

- Voltage input: 100/130 VAC, 48/63 Hz, or 200/260 VAC, 48/63 Hz.
- Consumption: 93 watts.

## FM 11-43

- Weight: 55 pounds.
- PRINTER:
- Speed: 150/240 CPS.
  - Voltage input: 100/130 VAC, 48/63 Hz.
  - Consumption: 13-watt average.
  - Weight: 11 pounds without paper.

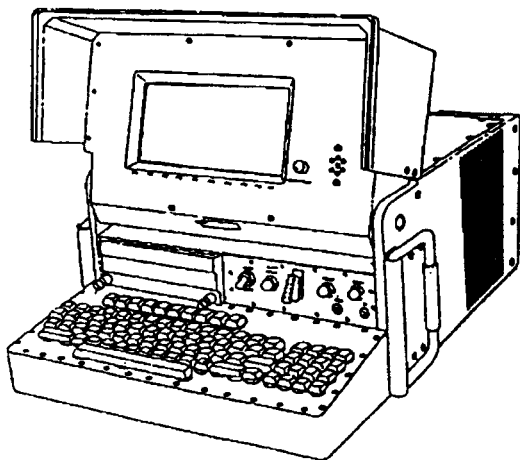

NOTE: Printer is separate.

*Figure 3-38. CT, AN/UGC-144.*

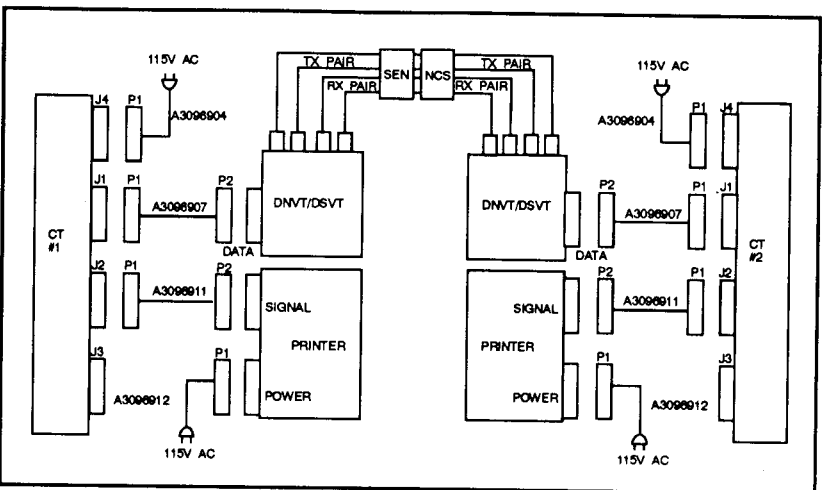

Figure 3-40. CT communications via MSE.

## Chapter 4

# Combat Net Radio

### 4-1. Overview

CNR refers to the family of both single-channel and frequency hopping (FH) radios which are organic to many types of units. In maneuver battalions, CNR is their primary means of communications.

The Army uses several types of single-channel radios which operate in different frequencies across the RF spectrum as shown in Figure 4-1.

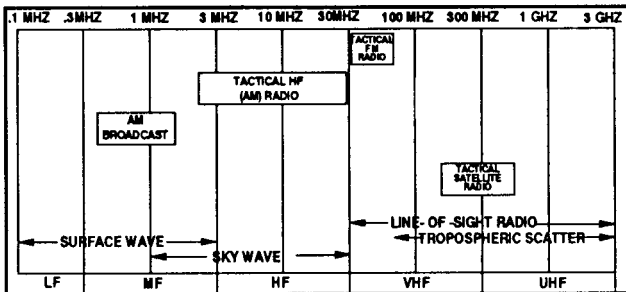

Figure 4-1. RF spectrum.

## FM 11-43

The Army uses the following single-channel radios:

- **FM Radio.** Its range is about 35 to 40 kilometers which covers a brigade/battalion maneuver area. FM radio transmissions are normally LOS which large terrain features can block. FM radios can also transmit data.

- **HF Radio.** HF radio's longer range overcomes terrain limitations for users with greater dispersion. Using the improved high frequency radio (IHFR) provides a versatile capability for short- and long-range communications. HF is the only tactical communications asset that may achieve long-range communications independent of terrestrial or satellite relays. HF communications may be either voice or secure data. HF is also useful where LOS cannot be achieved. The capabilities of the single-channel radio make it flexible, securable, mobile, and reliable. However, the radio is the most detectable means of electronic communications and is subject to intentional and unintentional electronic interference. Good ECCM and remoting techniques are highly recommended.

- **TACSAT Radio.** The use of satellite communications gives the commander the greatest range. It is useful to users separated by long distances, such as rapid deployment forces and special operations units. The single channel TACSAT radio transmits in the UHF/VHF range which requires the antenna to have LOS with the satellite.



Satellite access time must be requested in advance. This radio has a narrow and wide bandwidth and can transmit data.

These radios are used in functional networks such as command, administrative/logistical, fire support, and intelligence nets.

CNR's primary role is voice transmission for battle command. The CNR network can assume a secondary role for data transmission when needed. Voice C<sup>2</sup> takes priority over data in most networks. The family of CNRs includes—

- AN/VRC-12 series.
- SINCGARS.
- IHFR.
- Single-channel TACSAT.

#### **4-2. AN/VRC-12 Series Radios**

AN/VRC-12 series radios are short-range, vehicular, aircraft, and fixed-station mounted units. They provide FM radio communications with NRI and retransmission capabilities. The radios also can be used with speech security or digital data equipment. Table 4-1 shows the technical specifications of the AN/VRC-12 series radios.

***Note: The AN/VRC-12 series radios are being replaced by SINCGARS, discussed in paragraph 4-3 of this chapter.***

***Table 4-1. AN/VRC-12 technical specifications.***

● PRIMARY COMPONENTS:	Receiver-Transmitter, RT-524/RT-246
● FREQUENCY RANGE:	30-75.95 MHz (50 Hz spacing)
● PLANNING RANGE:	41 km (High Power) 8 km (Low Power)
● MODES OF OPERATION:	Voice/Data
● RF OUTPUT POWER:	8 watts (Low Power) 35 watts (High Power)
● TM NUMBER:	TM 11-5820-401-10 series

The AN/VRC-12 series radio sets are designed around two types of RTs: the RT-246 and the RT-524. The RTs are combined with other components to form eight different configurations. The other components are the radio receiver, R-442; the secure retransmission set, C-10374; the antenna, AS-1729; and an auxiliary antenna. Table 4-2 show the various radio configurations.

*Table 4-2. Radio configurations.*

RADIO	FEATURE	RT-246	R-442	RT-524	C-10374	AS-1729	AUX ANT
AN/VRC-12	Monitors 2 Nets	1	1	0	0	1	1
AN/VRC-43	Monitors 1 Net	1	0	0	0	1	1
AN/VRC-44	Monitors 3 Nets	1	2	0	0	1	2
AN/VRC-45	Retransmission	2	0	0	1	2	0
AN/VRC-46	Monitors 1 Net	0	0	1	0	1	0
AN/VRC-47	Monitors 2 Nets	0	1	1	0	1	1
AN/VRC-48	Monitors 3 Nets	0	2	1	0	1	2
AN/VRC-49	Retransmission	0	0	2	1	2	0

Figures 4-2 and 4-3 show all components for cabling used in a secure AN/VRC- 12 series radio.

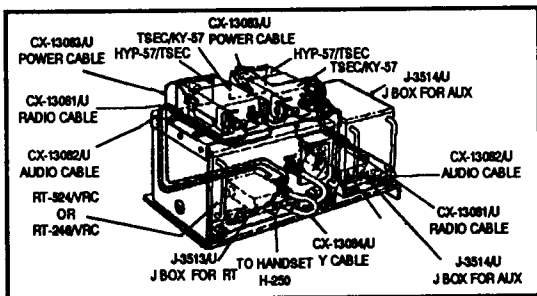

Figure 4-2. Radio set, AN/VRC-47 (secure).

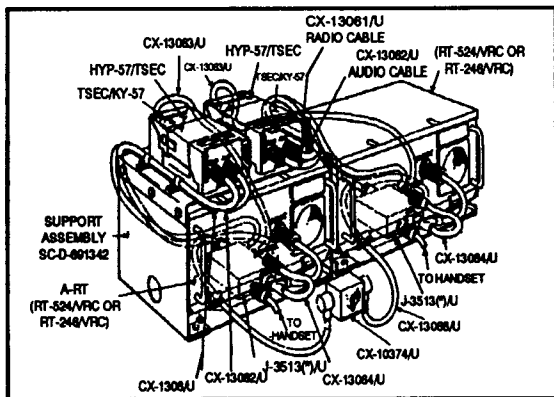

Figure 4-3. Radio set, AN/VRC-49 (secure).

### **4-3. Single-Channel Ground and Airborne Radio System**

SINGGARS is the primary radio system used for short-range secure voice communications at brigade/battalion. SINGGARS is the secondary means for CS and CSS units.

SINGGARS is replacing all AN/PRC-77 manpack and AN/VRC-12 series vehicular mounted and airborne VHF-FM radios. SINGGARS accepts either digital or analog input. It converts the signal into a FH output. In the FH mode, the radio's transmission changes frequency about 100 times per second. This prevents threat interception and jamming units from locating or disrupting friendly communications.

SINGGARS radios may "net" with the AN/VRC-12 series radios by operating in the single-channel mode. Additionally, the AN/VRC-12 series radios may operate within FH nets by using a SINGGARS-FH to single-channel (SC) retransmission system provided by an AN/VRC-92. Figure 4-4 shows an example of an SC to FH retransmission operation.

SINGGARS provides access into the ACUS network through the NRI. The NRI (KY-90) is the interface device which links the SINGGARS with the ACUS communications network. Normally, CNR users gain access through an NRI station located in either a SEN, FES, LEN, or NC.

***See FM 11-32 for detailed information on SINGGARS.***

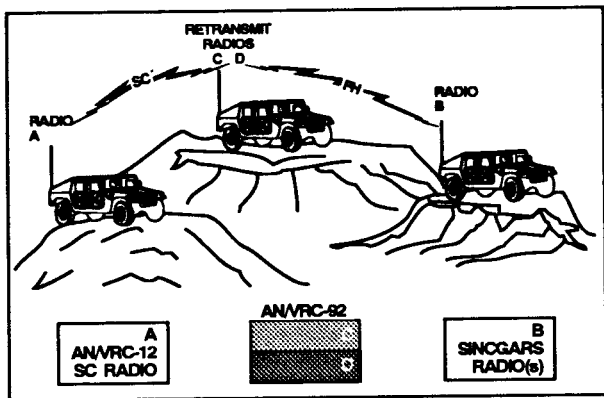

Figure 4-4. SC to FH retransmission operation.

Table 4-3 shows SINCGARS characteristics.

*Table 4-3. SINCGARS characteristics.*

● PRIMARY COMPONENTS:	Receiver-Transmitter, RT-1523 ICOM RT-1439 NON-ICOM RT-1476/77/78 AVIONIC
● FREQUENCY RANGE: (Channel Spacing)	30 TO 87.975 MHz 25 Hz
● PLANNING RANGE: Manpack/Vehicular:	LO - 200 to 400 meters MED - 400 meters to 5 km HI - 5 to 10 km
Vehicular Only:	PA - 10 to 40 km
● MODES OF OPERATION:	
Voice:	SC and FH
Retransmit:	SC to SC, SC to FH, FH to FH
Digital Data:	SC and FH
Remote:	With AN/GRA-39, CM, or RCU
Plain or Cipher Text (When KY-57 is attached)	
● RF OUTPUT POWER:	LO - 500 microwatts MED - 160 milliwatts HI - 4 watts PA - 50 watts
● DATA TRANSMIT RATE:	
Manpack/Vehicular:	HI - 3 to 5 km @ 600 to 4800 bps - 1 to 3 km @ 16 kbps
Vehicular Only:	PA - 3 to 10 km @ 16 kbps - 5 to 22 km @ 4800 bps - 5 to 25 km @ 600 to 2400 bps
● TM NUMBER:	TM 11-5820-890-10 series

## FM 11-43

The primary component of SINCGARS is the receiver/transmitter. There are two ground unit versions (RT-1523 integrated COMSEC (ICOM) and RT-1439 non-integrated COMSEC (non-ICOM)). See Figures 4-5 and 4-6. The main difference between radios is the device used to provide secure communication. The RT-1523 has internal COMSEC circuits and the RT-1439 uses the VINSON secure device. The secure devices are compatible if the same cryptonet variable is used in the ICOM radio and the VINSON device. The ground versions are equipped with a whisper mode for noise restriction during patrolling or while in defensive positions. The operator whispers into the handset and is heard at the receiver in a normal voice.

***NOTE: All double-stacked SINCGARS can be used as a retransmission station.***

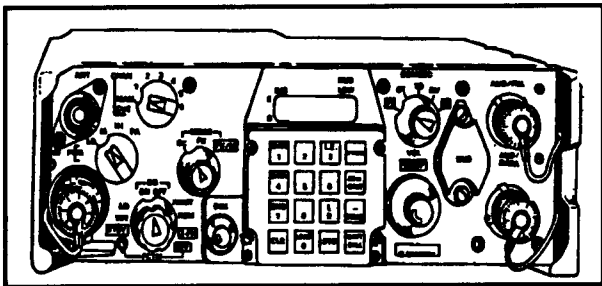

*Figure 4-5. ICOM radio RT-1523.*



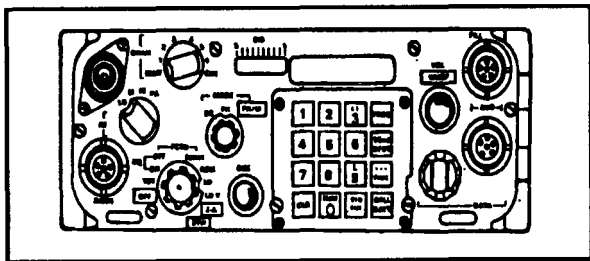

*Figure 4-6. Non-ICOM radio RT-1439.*

SINCGARS has seven different configurations.

**AN/PRC-119.** This is a manpacked version of SINCGARS which weighs about 20 pounds and can be carried in an all-purpose lightweight individual carrying equipment (ALICE) pack. See Figure 4-7. It is powered by a 13.5 volt lithium battery. The battery has an average life span of 12 hours (at 70° F when used with an RT ratio of 1 to 9). The average life span for the battery with the new RT-1523A/B is 26 hours. The AN/PRC-119 does not include a power amplifier and therefore has a planning range of 5 to 10 kilometers when used in the high RF position.

**AN/VRC-87 and AN/VRC-88.** These radios are short range and vehicular mounted. They are identical except that the AN/VRC-88 includes a battery box, whip antenna, and backpack shelf which gives it dismounting capability. See Figure 4-8.

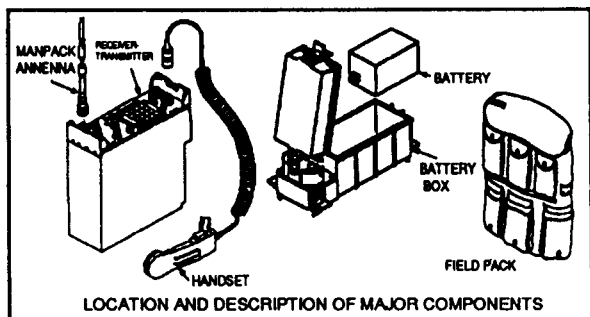

Figure 4-7. Radio set, AN/PRC-119.

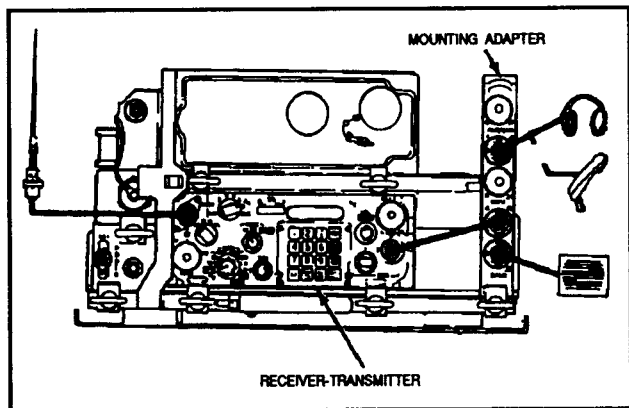
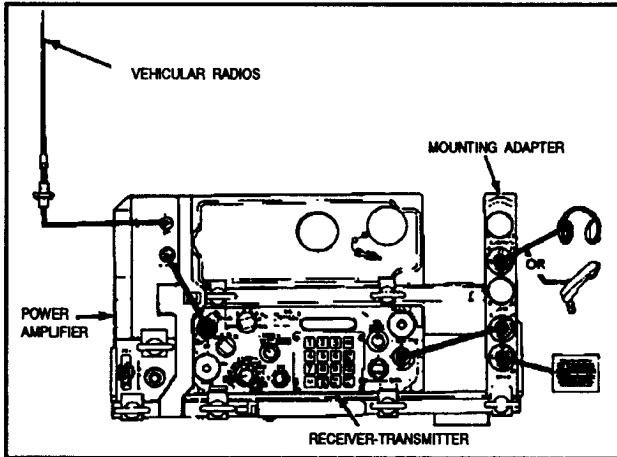

Figure 4-8. Radio sets, AN/VRC-87 and AN/VRC-88.

**AN/VRC-90.** This is a long-range, vehicular mounted radio set. It contains a power amplifier which uses a mount adapter to interface and support the RT. The power amplifier provides about 50 watts of RF power during transmission which boosts the radio's range. See Figure 4-9.



*Figure 4-9. Radio set, AN/VRC-90.*

**AN/VRC-89, AN/VRC-91, and AN/VRC-92.** These radio sets have two RTs. This enables the operator to monitor two different nets at once, or act as a retransmission station. The AN/VRC-89 and AN/VRC-91 sets have two RTs and one power amplifier which makes one radio long-

range and the other short range. The AN/VRC-91 includes a battery case, whip antenna, and backpack shelf which gives it dismounting capability. The AN/VRC-92 has two power amplifiers which boost the transmit power of its RTs. See Figure 4-10.

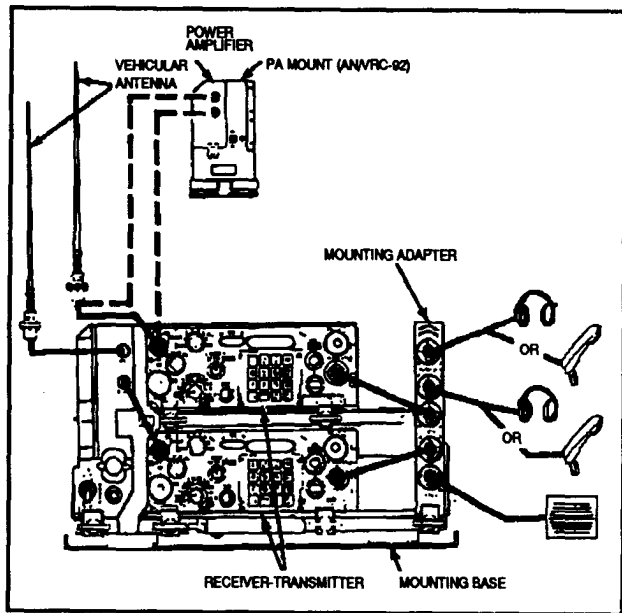

*Figure 4-10. Radio sets, AN/VRC-89, AN/VRC-91, and AN/VRC-92.*

**LOADING SECURE DEVICE KY-57**

The KY-57 VINSON is an auxiliary device used to secure radio transmissions from the AN/VRC-12 series radios and the non-ICOM SINCGARS sets. See Figure 4-11. To encrypt transmissions, it must be loaded with a COMSEC trunk encryption key (TEK) from a KYK-13 or KYX-15. The procedure for loading the KY-57 is as follows:

- Connect the KY-57 to the radio set.
- Set the KY-57 to C and fill register to a numbered position/ALL.
- Turn KY-57 power to ON (COMSEC alarm is heard).
- Press the handset push-to-talk button twice (COMSEC alarm clears to a steady tone).
- Set KY-57 mode to LD.
- Connect KYK-13 to KY-57 using fill cable.
- Turn KYK-13 to ON and fill register to a numbered position.
- Press the handset push-to-talk, and a beep is heard and the KYK-13 lamp blinks.
- Turn KYK-13 OFF and disconnect from the KY-57.
- Set the KY-57 MODE to C.

***NOTE: The Automatic Net Control Device (AN/CZY-10) will replace the KYK-13, KYK-15, MX-18290, and MX-10579.***

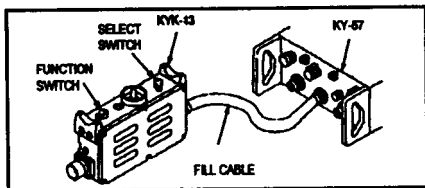

Figure 4-11. Loading a KY-57 VINSON fill.

## LOADING SINGARS FH DATA (LOCAL FILL)

To frequency hop, SINGARS must be loaded with specific FH data such as the transmission security key (TSK). This data is loaded from an ECCM Device, MX-10579 and should be loaded after the radio set is powered up. See Figure 4-12. The instructions for tilling the RT are as follows:

- Ensure the ECCM fill device is loaded.
- Set ECCM fill device function switch to OFF.
- Connect ECCM fill device to RT connector AUD/FILL using fill cable.
- Set RT FCTN to LD-V.
- Set RT MODE to FH.
- Set RT CHAN to MAN.
- Set ECCM fill device select switch to T1 or T2.

- Set ECCM fill device function switch to ON.
- Press HOLD. Display will show "LOAD," then "STOP." A beep is heard, the "COLD" is displayed.
- Set RT FCTN to LD.
- Set ECCM fill device function to OFF.
- Disconnect ECCM fill device from RT connector fill.

***NOTE: TSK is transparent with ICOM SINGARS and built as a part of hopset. Non-ICOM SINGARS requires separate identified TSK. There is no "LD-V" on the ICOM version.***

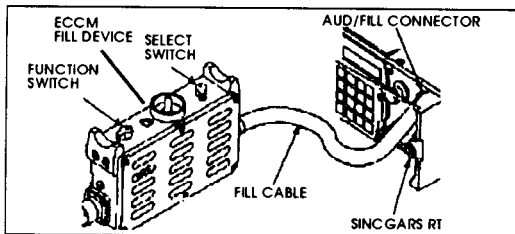

***Figure 4-12. Loading FH data fill.***

## RECEIVING AN ELECTRONIC REMOTE FILL

SINGGARS can receive FH data from a remote station. This data can be transmitted to the RT from a distant station, such as the net control station (NCS). The electronic remote fill (ERF) allows the RT's internal clock to synchronize with the other radios operating in the net. See Figure 4-13. The steps for requesting and receiving an ERF are as follows:

- Set COMSEC device to plain or clear.
- Set RT CHAN to CUE.
- Set RF to HI or PA. Key handset and call NCS.
- When NCS responds, follow their instructions.
- Set FCTN to LD.
- Set MODE to FH.
- Set CHAN to MAN. Display will show "COLD."
- Wait for NCS to transmit ERF.
- Upon receiving an ERF, press STO; then enter the channel number (on keypad) where it is to be stored.
  - Acknowledge reception of ERF to NCS.
  - Set CHAN to channel where hopset was stored.
  - Set FCTN to ON.

***NOTE: Precautionary measures must be taken to ensure that the KY-57 VINSON is loaded with a COMSEC trunk encryption key (TEK) from a KYK-13 or KYX-15 and not mismatched with the transmission security key (TSK) loaded from an ECCM fill device.***

*See FM 11-32 for more information on this subject.*



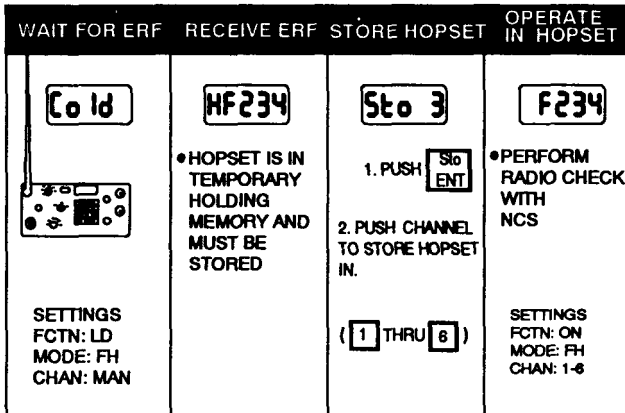

Figure 4-13. Receiving an ERF.

#### 4-4. Improved High Frequency Radio

The IHFR is a modular designed manpack or vehicular mounted radio operating at 2 to 30 MHz. It uses ground- and sky-wave propagation paths for medium- to long-range communications. The primary component of IHFR sets is the RT-1209. It is a single sideband (SSB) radio that operates in either the upper or lower sideband. Depending on the units' mission, the RT-1209 is combined with other components to create manpacked, vehicular, or fixed station radios. The components for the different configurations are relatively small, making the sets lightweight and versatile. IHFR accepts input of voice and data rates up to 2400 bps

## FM 11-43

when used with appropriate data modems. IHFR passes highly perishable C<sup>2</sup> information for medium-to long-range communications (50 to 300 kilometers). Brigade and battalion units primarily use the low-power version. All IHFRs are user-owned and operated. The Near Vertical Incidence Sky Wave (NVIS) Antenna, AS-2259/GR is an issued item with the IHFR's; however the NVIS antenna is interchangeable with the AN/GRA-50 and the whip antenna. The NVIS antenna may be remoted up to 61 meters (200 feet) from the radio set. Table 4-4 shows the IHFR characteristics.

*Table 4-4. IHFR characteristics.*

● PRIMARY COMPONENTS:	Receiver-Transmitter, RT-1209
● FREQUENCY RANGE:	2 to 29,999 MHz (100 Hz spacing)
● MODES OF OPERATION:	Single sideband (Selectable to upper sideband or lower sideband, voice, data, continuous wave, TTY, and receive-only)
● RF OUTPUT POWER:	20 watts or 100/400 watts (AN/GRC-193 only)
● DATA TRANSMITT RATE:	2400 bps

**AN/PRC-104A.** This radio set is a low power, lightweight, battery powered, tactical manpack configuration that replaces the AN/PRC-70/74 manpack radios. It weighs about 14 pounds and has automatic antenna tuning. The AN/PRC-104A will provide secure voice communications with the KY-65 or KY-99. See Figure 4-14. Its components are connected by quick-disconnect latches. The radio set consists of—

- Receiver-Transmitter, RT-1209.
- Amplifier/Coupler, AM-6874.
- Battery Case, CY-7875/PRC-104.

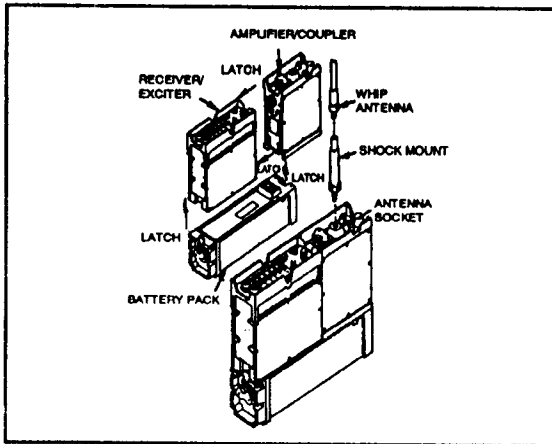

## FM 11-43

**AN/GRC-193A.** This radio set is high-powered and can be used in a vehicular or fixed station configuration. See Figure 4-15. IHFR sets perform retransmission for CNR when connected through the AN/VIC-1. Although more complex and bulkier than the other configurations, the AN/GRC-193A having strong output makes it ideal for long-range vehicular communications. The AN/GRC-193A radio is secured with the KY-65. Its components are—

- Receiver-Transmitter, RT-1209.
- Antenna Coupler, CU-2064.
- Amplifier/Converter, AM-6879.
- Power Amplifier, AM-6545A.
- Mounting Base, MT-6232.

**AN/GRC-213.** This radio set is a vehicular version of the 20 watt AN/PRC-104 radio and can be converted into a manpack configuration. The set includes three antennas: the whip, the doublet, and the NVIS antenna. The AN/GRC-213 will provide secure voice and data communications when used with the KY-65 voice or KY-99. See Figure 4-16. Its components are—

- Receiver-Transmitter, RT-1209.
- Amplifier/Coupler, AM-6874.
- Amplifier/Power Supply, AM-7512.
- Battery Case, CY-7152/PRC-104.
- Vehicular Mount.

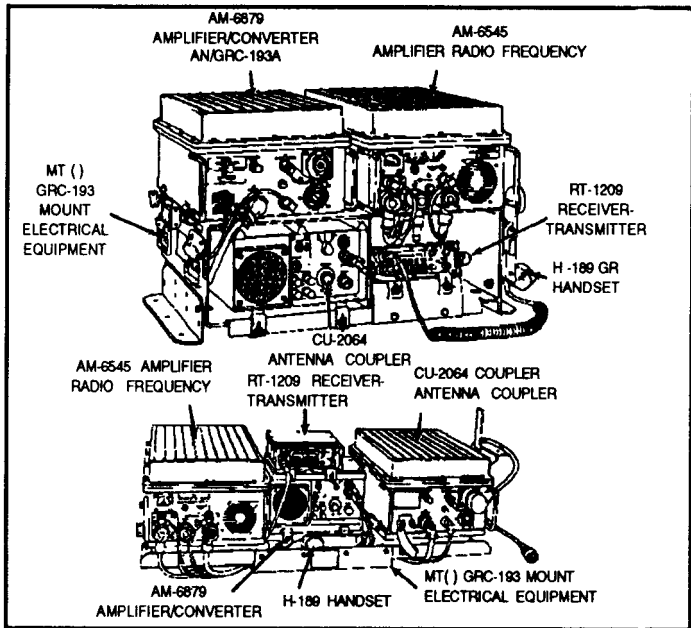

Figure 4-15. Radio set, AN/GRC-193A.

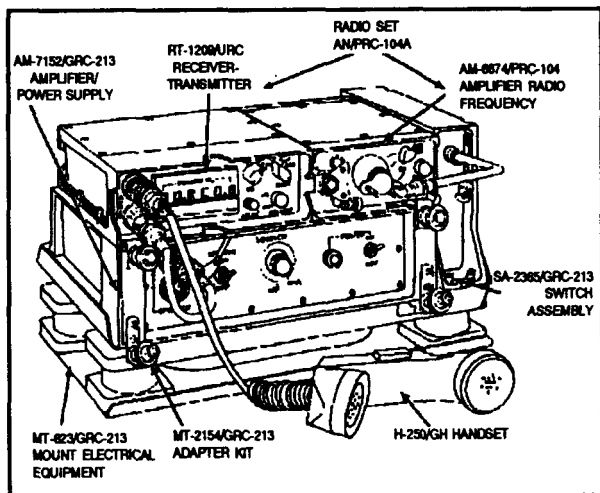

Figure 4-16. Radio set, AN/GRC-213.

#### 4-5. Single-Channel TACSAT System

The current single-channel TACSATs are the AN/URC-101, AN/URC-110, AN/VSC-7, AN/PSC-3, AN/PSC-5, and the AN/PSC-7 (MST-20 plus). These terminals provide reliable, highly portable communications support. They have minimum setup and teardown time and satisfy a need for extended distance communications. The systems operate between 225 to 400 MHz and use fleet satellite (FLTSAT) and Air Force satellite (AFSAT) space segments. The Army terminals using the FLTSAT space segments are the AN/PSC-3, AN/VSC-7, AN/URC-101, and the AN/URC-110.

## Chapter 5

# Basic Signal Leader Information

This chapter contains six sections. Each section provides guidance on performing a different task or area of importance common to signal leaders.

### Section I.

## Profiling Radio Links

Obtaining LOS between two stations is essential when forming a multichannel radio link. For most systems, the LOS planning range is about 40 kilometers, due to the earth's curvature. LOS analysis may be done by automated means, usually by the signal brigade's/battalion's S3. See Figure 5-1.

**To perform a manual radio LOS analysis, obtain the following materials:**

- Grid coordinates of both stations.
- Path profile paper,  $4/3$  earth radius (if possible).
- Map sheet containing both stations.
- GTA 5-2-12 protractor and coordinate scale.

**Perform the following steps:**

- On the map sheet, place a dot at each proposed site location and circle it for ease of finding it later.

## FM 11-43

- Draw a line from point A to point B and determine the distance between the two.

- If the distance is greater than 48 kilometers (40 kilometers for MSE), the points exceed maximum planning range and the transmissions may be too weak to receive. A relay may be needed; however, its use is undesirable and should be used as a last resort so that unnecessary assets are not tied up in one radio link.

- Determine the elevation in meters of the originating and destination stations. Plot them the proper distance apart on the profile paper. **Remember to add the antenna heights.**

- Divide the distance between the stations into 1 kilometer increments.

- Determine the highest elevation in meters at 1 kilometer increments. Plot these on the profile chart.

- Connect the points to establish a graphic picture of the terrain along the path between the two stations.

- Draw a straight line between the antenna stations. This line represents the multichannel radio transmission path.

- If the transmission path does not clear the terrain, LOS is not possible. Another terminal site or a relay site should be chosen. Leaders at company, platoon and team level should manually profile radio shots as soon as possible.

***TC 24-21 explains LOS manual profiling methods in detail.***



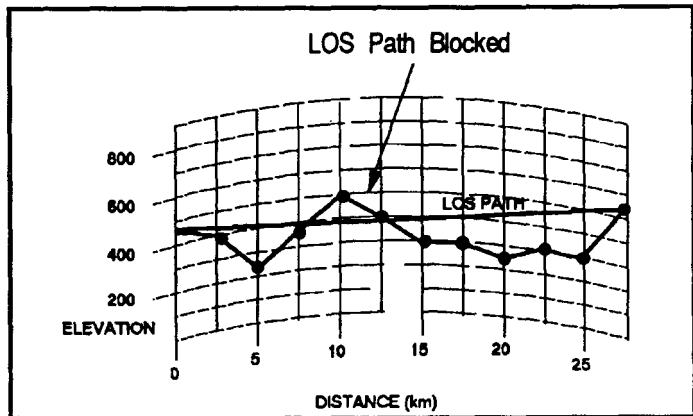

Figure 5-1. Sample LOS study.

## Section II.

### Conducting Convoy Operations

#### 5-1. Convoy Organization

A convoy is a group of vehicles organized under a single commander for movement. It consists of—

- **The march column.** All vehicles involved in a single move along the same route.
- **The serial.** Subdivision of vehicles moving from the same area along the same route.
- **The march unit.** Subdivision of a serial.

## FM 11-43

The march unit consists of march unit elements. These are—

- **Advance/Trail Elements.** These are not a part of the main march unit. They are detailed to perform special duties such as quartering and reconnaissance. Some tactical situations may require advance, flank, or rear guards. Heavily traveled routes and busy intersections may require guides, escorts, and patrols.

- **Lead Element.** First vehicle in the column. Contains the pace setter/navigator who ensures proper route and checks for changes to orders at predetermined points.

- **Main Body.** Column of vehicles comprising the bulk of the convoy.

- **Trail Element.** Last vehicle in the column. The trail element contains a trail officer/noncommissioned officer (NCO) responsible for maintenance and medical support.

### 5-2. Convoy Planning Factors

**Interval.** Distance between vehicles depends on many variables.

- Urban areas                      50 meters.
- Rural areas                        150 meters.
- Expressways                      200 meters.

**Convoy Speed.** Convoy speed depends on road conditions, traffic conditions, and the speed of the slowest vehicle.

- Cities/built up areas 24 Km/h (15 MPH).
- Two lane roads 40 Km/h (25 MPH).
- Limited access expressways 66 Km/h (40 MPH).
- Blackout Drive 8 Km/h ( 5 MPH).

**Convoy Security.** Military police (MP) units may provide convoy security on a continuous or intermittent basis. MP support depends on the threat in the area of operations. If MP units do not provide support, the convoy commander must plan for security. This includes—

- Noise and light discipline.
- Front, flank, and rear security.
- Security during halts.
- Air cover.
- Fire support.
- Communications.
- Checkpoints.

#### **Start and Release Points.**

- **Start point (SP).** This is where all elements of a column come under the control of the convoy commander. The SP must be a place along the route easily recognized on both maps and ground.

- **Release point (RP).** This is where elements of the column are released to their individual control. The RP, like the SP, must be a place along the route easily recognized on both maps and ground. The RP should have multiple exits to prevent congestion.

## FM 11-43

### **Halts.**

- **Time.** Plan 10 minute rest halts every 2 hours. Plan longer halts for dining, refueling, and bivouacking.

- **Location.** Choose halt locations in advance and identify good characteristic for dispersion and concealment according to operational conditions.

### **Personnel Duties During a Halt.**

- Officers and NCOs check the welfare of the soldiers, the security of loads, vehicular performance, fuel levels, and the performance of maintenance.

- Control personnel should inspect and give instructions to ensure the column begins with minimal confusion.

- Drivers should inspect their vehicles and loads.

- Drivers should perform preventive maintenance checks and services (PMCS)/during operations check.

- Assistant drivers must stay alert and be able to fill in for the driver when needed.

### **Additional planning factors.**

- Route reconnaissance.

- Tactical situation.

- Strip map preparation and distribution.

- Obtaining convoy clearance.

- Contacts along route for medical, decontamination, and vehicular support.

- Status of trained drivers.

- Number of vehicles involved.

- Types of loads.

- Traffic conditions.

- Communications for convoy control.

### 5-3. Convoy Commander's Brief

Before departing, the convoy commander should issue strip maps and conduct a briefing for all convoy members. Figure 5-2 shows a typical strip map.

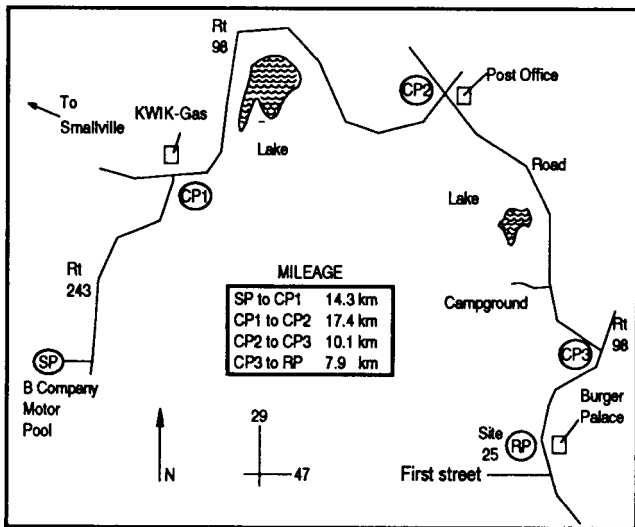

*Figure 5-2. Typical strip map.*

## FM 11-43

Recommended briefing subjects that should be covered are shown in the outline below.

### **Situation**

- Friendly forces.
- Support units.
- Enemy situation.

### **Mission:**

- Origin.
- Route.
- Destination.

### **Execution:**

- General organization of the convoy.
- Time schedule.
- Night operations.
- Risk assessment.

### **Route:**

- Convoy speed.
- Catch-up speed.
- Control personnel.
- Security forces commander.
- Fire support commander.
- Medical evacuation support and safety.
- Hazards of route and weather conditions.
- Defensive driving principles.
- Interval between vehicles.
- Decontamination points and contaminated routes.

**Emergency Measures:**

- Breakdown/accident procedures.
- Use of highway warning kits.
- Separation from convoy procedures.
- Ambush (actions taken).
- Contingency plans.

**Administration and Logistics:**

- Billeting arrangements.
- Messing arrangements.
- Refueling of vehicles.
- Supply support, Class I-IX.

**Command and Signal:**

- Primary and backup radio frequencies.
- Location and call sign of convoy commander.
- Location and call sign of assistant convoy commander.
- Location and call sign of medical support personnel.

***NOTE: Appendix O of FM 55-30 provides a sample convoy commander's checklist.***

### **Section III.**

## **Signal Site Selection/Set Up**

Select sites and routes using ground reconnaissance when possible. Use an aerial or map reconnaissance when a ground reconnaissance is not possible.

**Site Reconnaissance.** As soon as the team knows where it will deploy, it conducts a thorough reconnaissance. For an NC, this usually includes the platoon leader, platoon sergeants, LOS supervisor, security and NBC team. The NC's reconnaissance must be extremely detailed as site selection and layout are critical to network success. NC reconnaissance is considered complete when the platoon leader can fill out the NC diagram showing--

- Antenna and LOS(V3) placements.
- RAU locations.
- NC switch/NMF locations.
- Hasty defensive sites and security plans.

The LOS has first priority of placement, the local RAU second, and the NC switch/NMF last. The platoon leader also determines if the database needs modifying and back briefs his command on his site layout and initial security procedures.

**Site Selection.** Select the site that best meets the following criteria:

- Site should be level and allow sufficient space for tactical dispersion of communications equipment in addition



to subscriber space requirements.

- Site must have a clear LOS path for radio systems, must be free of obstacles that prevent transmissions, and away from interference sources such as power lines, generators, or other antennas.

- Site should be accessible in all weather conditions.

- Site should provide overhead cover and concealment with adequate dispersion of assets, be defensible, have more than one exit, and not attract enemy attention.

- Site should have a helicopter landing zone for emergencies or supplies.

**Site Planning.** Once a site has been chosen, do the following in accordance with the unit SOP:

- Estimate equipment placement, subscriber location, initial observation post, sleeping, dining and latrine areas, dismount points, parking space, and restricted areas.

- Draw a site sketch including the above items.

- Coordinating for the site with higher headquarters, subscriber units, and other appropriate elements.

- Prepare strip map with primary and alternate routes to the site.

- Distribute strip maps to appropriate personnel.

**Site Set-up.** The following are points to consider when setting up a signal site:

- Maintain a tactical configuration and position the operations van in a central location. This allows easy control of the site.

- Position the radio vans on the edge of the site in the direction they will be shooting. This allows the antennas

## FM 11-43

to have the most direct shot without crossing anything on the site. Generators and power lines must be kept as far away from the antennae as possible.

- Maintain switches in a central location to allow ease of installing cables to multichannel and other radio vans.
- Allow easy access to generators.
- Back vehicles into designated parking areas to allow for rapid displacement.

### Section IV. Signal Site Security

#### 5-4. Types of Signal Sites

Signal sites must be able to defend against sabotage, ground forces, and airborne/air assault forces with little or no outside help. They must also be prepared to survive enemy air, artillery, and NBC attack.

There are different signal sites and different considerations must be made when planning a site defense for each. Current threat status/situation is an important factor when planning and committing assets and personnel to defend a site. Use mission, enemy, terrain, troops and time (METT-T) considerations and order priorities accordingly.

**Remote Sites.** These are small teams located in isolated positions, usually for relay or retransmission purposes. They cannot hope to defeat a large enemy force. Teams should try to remain concealed and report enemy activity

to higher headquarters. Conduct risk assessment for remoted sites to determine the probability of mission success. Leaders must carefully track specific threats and move quickly when in danger.

**Collocated Sites.** These are usually teams that deploy to support a unit CP, such as an extension node. Usually, the team members are responsible for a portion of the perimeter defense. Careful coordination must be done with the collocating units. All defense matters for the site should be the responsibility of one central authority.

**Node Sites.** This is usually a platoon-sized signal unit that may or may not collocate with another unit. Based on the +6 enemy threat level, the signal site commander must plan a site defense and coordinate with nearby units for mutual support.

## **5-5. Site Defense Tasks**

The following list provides guidelines for planning a site defense and should be prioritized according to the mission.

- Set up a dismount point and a blackout drive line.
- Park vans at least 50 meters apart or as dictated by the tactical situation and/or environment to allow minimum damage from indirect fire.
  - Camouflage tents, vehicles, and equipment.
  - Set up defensive positions with interlocking fields of fire.
  - Ensure aiming stakes are in place and place antipersonnel mines along probable foot approaches.
  - Set up personal defensive positions within the site.

## **FM 11-43**

- Establish overhead cover.
- Establish a site defense command center.
- Establish listening points outside earshot of generators.
  - Establish a roving guard force to cover the perimeter and check on fighting positions.
  - Establish external patrols to periodically sweep the immediate area outside the perimeter.
  - Position and over-watch obstacles, mines, and trip wires.
  - Position light antitank weapons (AT-4) along vehicle approach routes.
  - Establish perimeter control.
  - Ensure communications exist to observation/listening posts, dismount points, fighting positions, and casualty evacuation points.
    - Establish an additional line between collocating units and the signal command center.
    - Set up NBC monitoring equipment.
    - Establish rally points and reactionary force plan.
    - Coordinate a call for fire plan.
    - Inventory sensitive items often to provide an accurate battle status.
    - Plan for medical support and evacuation.
    - Set up ammunition resupply points.
    - Set up a viable sleep plan that integrates into the work/defense plan.
    - Control weapons employment and ensure each soldier has adequate ammunition (with magazines).
    - Rehearse your plan according to the standards outlined in the appropriate Army Training and Evaluation

Programs (ARTEPs), soldiers manuals, and/or SOPs. (See Appendix C.)

Figure 5-3 gives a typical signal site defence diagram.

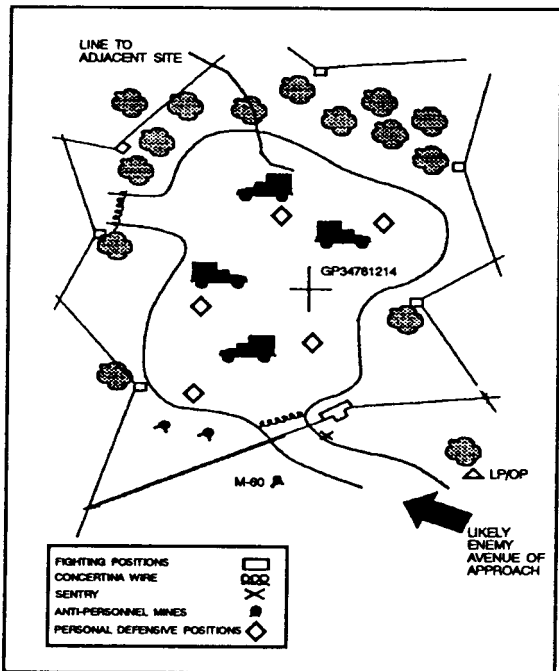

*Figure 5-3. Signal site defence diagram.*

## Section V. Communications Under Special Conditions

The environment can take a severe toll on communications. This section addresses a few specific problems involved in six environments: cold weather, desert, jungle, mountain, urban, and nuclear.

***NOTE: The operator must perform PMCS to maintain all equipment in an operational status.***

### 5-6. Cold Weather Operations

Soldiers must be trained on cold weather safety. Extra precautions must be taken with heaters and open fires. Carbon monoxide poisoning is a constant danger. Snow and ice build-up on tents and vehicle canvas can cause tearing.

**Generators and Vehicles.** Grounding is difficult in frozen earth. Gloves must be worn when handling all metal objects. If possible, use existing underground pipes or above ground structures to get an adequate ground. Antifreeze and lightweight oil must be used for all vehicles during cold weather operations. Liquid cooled generators also need antifreeze. Maintenance personnel must check antifreeze levels often. Water may appear in fuel and fuel lines. Do not use contaminated fuel. The fuel must be

drained from the vehicle and new fuel added before operating the vehicle. Keep dry batteries warm and charge wet-cell batteries. Vehicles must be started at least once a day and operated for 10 minutes at a high revolutions per minute (RPM) to charge the battery. Keep tire chains tight to avoid damage to vehicles.

**Radios.** Water vapor from the breath can freeze and make a microphone useless. Use de-icing shields to prevent this. Ice on antennas can cause damage and make it hard to extend or lower the antenna. Ice can be melted from the mast using a hose attached to the exhaust pipe of a vehicle. Direct the hot air on the ice until it melts.

**Wire.** Condensation and ice on connectors make connecting the cables difficult and can degrade the signal path. Care must be taken to keep connectors dry. Extreme care must be taken in handling cables at low temperatures. When the rubber jackets become hard, the cables must be protected from stretching and bending to prevent short circuits caused by breaks in the covering. If cables are to be bent, they must first be warmed.

## **5-7. Desert Operations**

Two of the biggest problems involved in desert operations are dust and extreme heat. Dust and sand particles damage equipment. The heat can take its toll on generators, wire, communications equipment, and personnel.

## FM 11-43

**Generators and Vehicles.** Grounding equipment is difficult and can be accomplished by burying grounding plates in the sand and frequently pouring salt solutions on them. Special attention must be taken to ensure air filters are cleaned daily to prevent equipment damage.

**Radios.** Keep all radios cool and clean. Keep them in a shaded or ventilated area whenever possible. Cover hot radios with a damp towel without blocking the air vents. Evaporation will cool the radio. After dark, rapid temperature drops can cause heat inversion that can disrupt radio communications until the atmosphere stabilizes. Desert terrain can cause excessive signal attenuation making planning ranges shorter.

**Wire.** Bury wire and cables deep in soft sand, if possible. This prevents damage to the cable insulation.

*See FM 90-3 for more information on desert operations.*

## 5-8. Jungle Operations

During jungle operations, movement and visibility are reduced by terrain and heavy foliage. This same terrain and foliage provides adequate cover and concealment. Humidity and heat can cause condensation. Microphones, wires, cables, end gauges are especially susceptible to moisture and fungus. Battery life is shortened. If air conditioning is available, it is very effective against high humidity.



**Radios.** The range of radio communications is reduced. VHF and UHF radios are limited by jungle growth and terrain that absorb transmissions. HF radios are more effective. Airborne radio retransmissions are used to overcome dense vegetation.

**Wire.** Dense vegetation and difficult terrain limit using wire in jungle operations. Aerial wire installation can be used as an alternate dispensing method due to mobility restrictions in jungle terrain.

*See FM 90-6 for more information on jungle operations.*

## 5-9. Mountain Operations

Mobility is difficult in mountainous terrain, and it can be difficult to find a level area for a communications site.

**Generators and Vehicles.** Generators and communications assemblages need level ground to operate properly. It is difficult to drive ground rods and guy wire stakes into rocky, mountainous terrain. The rocky soil provides poor grounds, however, adding salt solutions will improve the electrical flow.

**Radios.** When operating in mountainous terrain, additional retransmission assets will be needed. LOS paths are much more difficult to gain. Use of relays improves communications. Positioning antennas is crucial in mountainous terrain because moving an antenna even a small distance can drastically affect reception.

*See FM 90-6 for more information on mountain operations.*

### **5-10. Urban Operations**

Seizure of cities and towns consume enormous resources, degrade the momentum of offensive operations, restrict maneuver, and are time-consuming.

**Radios.** Large buildings and electrical interference greatly hamper LOS communications. Using retransmission helps to alleviate the problem. Aerial retransmission is the most effective. If this is not available, install antennas as high as possible. Avoid using church steeples and other obvious places. It is better to select a common type of building and install the antenna. Consider the background before camouflaging antennas. Remember to remote radios to separate the operators from the equipment. Position retransmission stations near intersections to provide better coverage.

**Multichannel Radio.** The effectiveness of multichannel radio is reduced in an urban area because the radios require LOS. LOS between units is nearly impassible in built-up areas. Install multichannel radio systems only after the city is relatively secure. Use an SHF radio shot to bring the circuits into the supported headquarters.

**Telephone and Wire.** The prompt seizure of the city and existing communications facilities are very important. Notify parent headquarters of controlled telephone numbers. Public or private telephones coupled with

stationing messengers at the phones can provide excellent emergency communications. Initially, telephone and wire lines have limited use. Installation in sewer systems, subway tunnels, or through intact buildings provides increased protection for the wire. Use aerial or overhead construction when installing wire along city streets.

**Visual Signals.** Pyrotechnics, smoke, and marking panels are means of communications in the city.

## **5-11. Nuclear Environment**

A nuclear environment is very damaging to sensitive signal equipment. Leaders must know how to protect vital assets for future use.

**Electromagnetic Pulse (EMP).** The radiation from a nuclear burst produces EMP. Gamma rays radiate outward from the burst and strip electrons from the atoms in the air. This creates a virtual wall of fast-moving electrons as the radiation sweeps outward in an expanding wave. This process creates a region of high voltage and strong interference.

**Susceptibility.** Signal equipment is very susceptible to EMP. Normally, the smaller the individual component, the more susceptible it is to electronic attack (EA).

**EMP Protective Measures.** All equipment not required in primary systems should remain disconnected and stored within a sealed shelter or other shielded enclosure for protection from the EA. This measure reduces the

## FM 11-43

likelihood of all equipment being simultaneously damaged by EMP and provides for backup components to reinstall affected systems.

**Wire and Cable.** Wire and cable should be shielded and properly grounded. The cable length must be kept as short as possible. Shields on all cables connect to the grounding systems where provided.

**Radios.** Antennas should be disconnected from radio sets when not in use. Reduce operational nets to a minimum. Most tactical radios with fully closed metal cases will provide adequate EMP protection if all external connectors have been removed. Placing items in vehicles, vans, and underground shelters provide effective protection.

## Section VI. Power Generation Sources

### 5-12. Batteries

Signal equipment can use two types of batteries:

- **Wet-Cell Batteries.** These contain electrolytes and normally provide greater amperage than dry cell batteries for tasks like starting vehicles. They require special attention to maximize their life span.

- **Dry-Cell Batteries.** These do not need water or acid. They can power smaller equipment such as radios, flashlights, and SB-22 switchboards. They can be ordered

through the supply system and kept on-hand until needed. Dry cell batteries should be refrigerated to increase their life span and should be removed from equipment when not in use.

It is crucial to maintain an adequate supply of batteries for the unit. Use the following guidelines to develop an SOP:

- Determine the unit's battery needs. Refer to the property book to find equipment that uses batteries. Look in the equipment training manuals to determine the type and number of batteries each item takes and how long the batteries will last.
- Determine the unit's battery usage and needed stockage level. Use Supply Bulletin 11-6 to obtain battery stock numbers, compute their storage life, and handling/disposal requirements.
- Ensure PLUS requisition required stock.
- Make a chart to keep track of the information. Table 5-1 shows an example of the chart.

BATTERY	EQUIPMENT	HOURS @ 70° F	OPERATING TEMP MAX	HOURS @ MAX OP TEMP	OPERATING TEMP MIN	HOURS @ MIN OP TEMP	NSN 6135-01-
BA-5112/U	AN/PRC-112	20	131° F	20	-40° F	6	235-4168
BA-5372/U	AN/PRC-119	500	125° F	500	-20° F	180	214-6441
BA-5372/U	TSEC/KY-57	2300	130° F	2300	-40° F	1000	214-6441
BA-5372/U	TSEC/KY-68	1800	140° F	1800	-40° F	1000	214-6441
BA-5567/U	AN/AVS-6	16	125° F	15.5	-25° F	8	090-5365
BA-5567/U	AN/PVS-4	46	127° F	40	-20° F	29	090-5365
BA-5567/U	AN/PVS-5 SERIES	32	120° F	32	-20° F	18	090-5365
BA-5567/U	AN/PVS-7 SERIES	32	120° F	32	-20° F	18	090-5365
BA-5567/U	AN/TVS-5	46	127° F	40	-20° F	29	090-5365
BA-5567/U	AN/VVS-2	23	120° F	20	-20° F	12	090-5365
BA-5588/U	AN/PRC-126	56	130° F	56	-40° F	19	088-2708
BA-5588/U	AN/PRC-68	33	130° F	33	-40° F	12	088-2708
BA-5590/U	AN/PRC-119	20	125° F	20	-20° F	12	036-3495
BA-5590/U	AN/TAS-4A	5	125° F	5.2	-40° F	2	036-3495
BA-5590/U	AN/TAS-6A	5	125° F	5.2	-40° F	2	036-3495
BA-5590/U	TSEC/KY-57	53	130° F	53.2	-40° F	21.5	036-3495
BA-5598/U	AN/PRC-77	57	140° F	57	-40° F	30	034-2239
BA-5598/U	AN/UGC-74	6	155° F	5.8	-25° F	4	034-2239

Table 5-1. Sample portion of unit battery storage chart.

### 5-13. Commercial Power

This power is normally very reliable. However, in the event of power failure backup generators and vehicle DC power systems are vital alternatives. As a fail-safe measure, backup power cables should be run to the tactical generators.

### 5-14. Engine-Driven Generator Units

Tactical generators can produce either AC or DC. DC generators can have output capacities from 0.4 to 15.9 kilowatts. AC generators can have output capacities from 0.3 to 1000 kilowatts.

Table 5-2 gives the approximate fuel consumption rates of various generators. When operating at medium to high temperature (50° to 100° F), a generator will consume oil at one quart per eight hours of operation.

*Table 5-2. Fuel consumption rates.*

1.5 kilowatt generator ->	5 gal per 8 hours
3.0	8
5.0	8
10.0	2.5

### 5-15. Generator Pre-Start Up Checklist

Use the following checklist when employing generators for power:

- Are TMs and PMCS lists available?
  - Is the generator located on a flat surface, not more than 15° from level?
  - Are brakes set and wheels blocked securely to prevent any movement of the trailer?
  - Are all exhaust pipes and air intake filters free of obstructions?
  - Is grounding rod driven at no less than a 45° angle into the ground?
  - Are ground straps securely connected?
  - Does the engine have any loose or missing wiring?
- Any oil or fuel leaks? Are air and fuel filters clean?
- How often is the oil changed or checked?
  - Have fuel containers been placed at least 50 feet from equipment and a fire point set up?
  - Are backup generators completely installed and ready for use?
  - Is the safety leg on the trailer being used?
  - Are drip pans present and being used?



## Appendix A

# Communications Planning Guide

The signal staff planning process has evolved continually for each of the BOSs. The signal officer must understand what steps and methods make a good, timely staff product that supports the 1/3 - 2/3 rule of planning. Staff estimate planning should always include all assets and not be done in a vacuum. Signal planning must be coordinated with all staff elements that support an operation. Each of the staff supports a different BOS and collectively the BOSs support a combined arms effort that is integrated and synchronized to support an objective. When the commander issues his initial guidance, he is giving his intent (the big picture) on how to accomplish the mission. The XO's job is to maintain control of the staff. He—

- Established a time line for staff planning that supports the 1/3 - 2/3 rule of planning.
- Establishes rehearsal times.
- Is responsible for backward planning and completing a good staff product.
- Is the timekeeper once the staff planning process begins and adjusting the process when necessary.
- Is responsible for keeping the staff focused on each planning step.

## FM 11-43

A normal time line covers the following areas:

### **Receive the Order from Higher.**

**Mission Analysis.** Conduct initial mission analysis to include specified and implied tasks. (Individual, staff then collectively.)

**Initial Intelligence Preparation of the Battlefield (IPB) Process.** Does the staff understand what the threat is and how it effects each of the BOSs?

**Commanders Guidance.** This is when the staff states whether their BOS can support the mission. This is really the staff estimate. After the commander has all the staffs input, he then issues further clarifying guidance and refocuses on his intent on how he sees the mission being executed and what he thinks is or will be critical.

**Develop Courses of Action.** Look at and develop the three or four most logical means of accomplishing the mission, for example, right, left, or up the middle.

**Analyze Courses of Action.** As a staff collectively and hypothetically resource and execute each mission course of action (COA) and determine its validity, risk, and chances of success. A decision matrix may be used to verify or support the staffs recommendation of a particular COA to the commander.

**Decision Briefing.** To select a final COA that will be further wargamed and developed by the staff and turned into the final plan/order that is issued to subordinate units.

**Wargame.** This is the most critical part of developing an operation. The XO and staff are tasked to coordinate each BOS and to ensure that their individual staff planning supports the operation/mission. Further, they must ensure their planning does not conflict or hinder any other BOSs operation on the ground/air. Offensive operations are usually planned in phases, but, whatever technique is used coordination is the key. An example of poor wargaming and resource synchronization would be if on a particular mission a key piece of elevated terrain sat at or just behind the forward line of own troops (FLOT). During the execution of the mission, several different separate teams tried to occupy this piece of terrain at the same time and it was only large enough physically and electronically for one of the teams to occupy. This lack of specific coordination may cost the successful employment of several key systems to support the combined arms fight. Do a risk assessment to determine the degree of risk involved in mission accomplishment. See Appendix D.

**Publish the Order.** Have a method to copy and disseminate quickly.

## FM 11-43

**Issue the Order.** The commander, XO, and/or the S3 briefs to subordinate units what the mission is and how it is going to be executed from brigade level. At this point only 1/3 of the available time should be used up if the XO/S3 did his job.

**Backbrief.** Done by subordinate commanders to ensure the commanders intent is understood. Subordinate commanders explain their mission and how they are going to execute it (if possible actually talking it out on the ground close to a scale terrain model of the area of operation.) The staff also briefs how their particular BOS will support and any critical points to watch for.

**Rehearsal.** Done at all levels - brigade down to individual teams. This is sometimes done with the backbrief to verify what was briefed by the commander and usually by phase of an operation. The most dangerous thing that can happen during the rehearsal is that it turns into a second wargaming process because the initial wargaming was inadequate or incomplete. This is not a time to be making key staff coordination or changing the plan.

BSOs should address communications problem areas at the maneuver rehearsal. Recommend practical and common-sense advice to the maneuver commander. Address both FM and MSRT communications. Discuss details of the retransmission and antijam plans specifically reference fire support communications if possible.

Reconnaissance and surveillance (R&S) assets such as scouts and other observer teams frequently conduct separate rehearsals run by the S2. These are critical assets requiring detailed instructions and redundant communications. The BSO or his representative should also attend this rehearsal, ensuring various teams fully understand the instructions and contingencies.

Figures A-1 through A-9 give examples of the planning process.

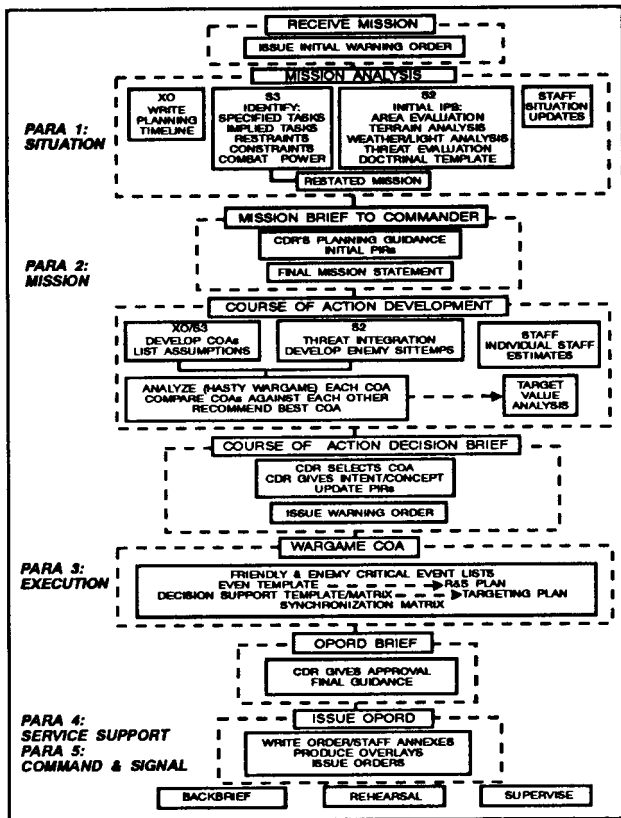

Figure A-1. Maneuver orders process.

<b>WARGAME BRIEFING</b> (for each COA)	
MISSION	BSO, S3
Updated terrain, weather, and enemy situation	BSO, S2
Enemy courses of action wargamed	BSO, S2
The course of action wargamed	BSO, S3
Assumptions	BSO, S3
Wargame techniques used (belt, box, avenue)	BSO, S3
Critical events wargamed	BSO, S3
Visualization of the entire operation (use synchronization matrix and COA worksheet along with COA statement and sketch)  -Each critical event  - Actions one level down  - Combat support and combat service support units needed for mission accomplishment	BSO, S3
Possible enemy actions/reactions considered during wargaming	BSO, S2

*Figure A-2. Wargame outline.*

<b>WARGAME BRIEFING</b> (for each COA)	
<p>Results of the wargame</p> <ul style="list-style-type: none"> <li>- Modifications of the COA (if required)</li> <li>- Proposed task organization and organization for combat to support the COA</li> <li>- Decision support template and decision support matrix (recommend NAIs, TAIs, HVTs, and HPTs)</li> <li>- Priorities for combat and combat service support units</li> <li>- Estimated time required for the operation</li> <li>- Estimated enemy losses (provided by S1)</li> <li>- Estimated friendly losses (provided by S1)</li> <li>- Advantages of the COA</li> <li>- Disadvantages of the COA to include any accepted risk</li> </ul>	BSO, S3
Staff Estimate (decision matrix)	BSO, ALL
Decision by XO on which COA to recommend	BSO, XO

*Figure A-2. Wargame outline (cont).*



<b>COMMUNICATIONS PLANNING PROCESS GUIDE CORPS AND BELOW (MANEUVER UNIT ORIENTED)</b>	
<b>ISSUE WARNING ORDER BEFORE ORDER IS RECEIVED TO SUBORDINATES:</b>	
<ul style="list-style-type: none"> <li>● 1/3, 2/3 RULE</li> <li>● COMM CHIEF</li> <li>● SEN CHIEF</li> </ul> <p>WHERE AND WHAT TIME TO MEET TO DISCUSS NEW ORDER AND ITS IMPACT ON COMMUNICATIONS. (ABOUT 30 MIN AFTER ORDER IS RECEIVED AT MAIN CP). MAPBOARD SHOULD BE AVAILABLE.</p>	
<b>DIV ORDER RECEIVED:</b>	
<ul style="list-style-type: none"> <li>● GET GUIDANCE FROM XO ON STAFF PLANNING TIMELINES</li> <li>● RECEIVE SIGNAL ANNEX AND COPY OF ORDER</li> <li>● TRACE BASIC GRAPHICS WITH AT LEAST BOUNDARIES AND PHASE LINES</li> </ul>	
<b>ORDER/ANNEX INFORMATION TO BE GLEANED:</b>	
<ul style="list-style-type: none"> <li>● LOCATIONS OF:               <ul style="list-style-type: none"> <li>-DTC</li> <li>-DTAC</li> <li>-NODE CENTERS</li> <li>-DIV RETRANS</li> </ul> </li> <li>● SPECIFIED AND IMPLIED</li> <li>● ATTACHMENTS</li> <li>● DETACHMENTS</li> <li>● RESTRICTIONS</li> <li>● CONSTRAINTS</li> </ul>	
<b>INITIAL COMMUNICATIONS PLANNING</b>	
<ul style="list-style-type: none"> <li>● ANALYZE TERRAIN</li> <li>● POSITION OF C2 FACILITIES</li> <li>● COORDINATION WITH:               <ul style="list-style-type: none"> <li>-XO/S2/S3/HHC CDR FOR TAC/TOC LOCATIONS</li> <li>-S1/S4 FOR BSA LOCATIONS</li> <li>-ADSO-NOTIFICATION/PROFILING</li> </ul> </li> <li>● RETRANS POSITIONING--TIME AND LOCATION STATED IN ORDER</li> <li>● OUTSIDE COORDINATION W/ADSO OR OTHER ADJACENT UNITS (PASSAGE OF LINES/RESERVE ROLL, CALL SIGN, FREQ)</li> <li>● ANTIJAM PLAN</li> <li>● SOL/CNV</li> <li>● BDE OP TEAMS/SCOUTS</li> <li>● WHO IS ON THE LEFT AND RIGHT</li> </ul>	

*Figure A-3. Communications planning process guide, maneuver unit oriented.*

<p><b>COORDINATION WITH OTHER STAFF MEMBERS:</b></p> <p><b>S1/S4</b></p> <ul style="list-style-type: none"> <li>• LOCATION OF BSA</li> <li>• MAINTENANCE PRIORITIES (SIGNAL EQUIPMENT)</li> </ul> <p><b>S2</b></p> <ul style="list-style-type: none"> <li>• ENEMY COMM ACTIVITIES, LOCATIONS, OBSTACLES, ARTILLERY ETC. IN RELATION TO C2 FACILITIES</li> <li>• USE OF SIGNAL ACTIVITIES OF DECEPTION OPERATIONS</li> <li>• LIGHT DATA FOR ANY NIGHT MOVES FOR RETRANS</li> <li>• ANY BDE OPS, SCOUT OR OTHER ATTACHMENTS TALKING ON BDE O / I</li> </ul> <p><b>S3</b></p> <ul style="list-style-type: none"> <li>• C2 FACILITY LOCATIONS</li> <li>• PASSAGE OF LINES, COLLOCATION OF C2 FACILITIES</li> <li>• HOW WILL RETRANS GET TO ITS SUPPORTING LOCATION</li> </ul> <p><b>FSO</b></p> <ul style="list-style-type: none"> <li>• NO FIRE AREA AROUND RETRANS</li> </ul>
<p><b>ESTIMATE BRIEF TO COMMANDER:</b></p> <ul style="list-style-type: none"> <li>• GENERAL TERRAIN ANALYZE</li> <li>• COMM STATUS</li> <li>• IMPLIED AND SPECIFIED TASK</li> <li>• RESTRICTIONS</li> <li>• CONSTRAINTS</li> <li>• ATTACHMENT/DETACHMENTS</li> <li>*BOTTOM LINE: CAN WE SUPPORT THE MISSION WITH COMMUNICATIONS?</li> </ul>
<p><b>ORDERS ISSUE BRIEF TO SUBORDINATE COMMANDERS:</b></p> <ul style="list-style-type: none"> <li>• LOCATION OF TAC CP, MAIN CP, AND RETRANS POSTED (INDICATE LOCATION OF EACH ON MAP)</li> <li>• LIKELY AREAS OF COMMUNICATIONS PROBLEMS</li> <li>• ANY RESTRICTIONS-RADIO LISTENING SILENCE ETC.</li> <li>• ANTIJAM PLAN</li> <li>• CHANGES TO SONVARIABLES (CHANGE EDITIONS, OPERATION TO CONTINUE PAST NEW CHANGE OVER PERIOD ETC.)</li> </ul>
<p><b>ISSUE INSTRUCTIONS TO SUBORDINATES AND COORDINATION WITH HIGHER:</b></p> <ul style="list-style-type: none"> <li>• RETRANS WARNING ORDER</li> <li>• ANTIJAM PLAN</li> <li>• PROPOSED C2 LOCATIONS-CONTACT ADSO ABOUT JUMP LOCATIONS-WILL THEY PROFILE, RAU COVERAGE</li> </ul>
<p><b>POST ORDERS ISSUE:</b></p> <ul style="list-style-type: none"> <li>• CHECK WITH FSO ON NO FIRE AREA AROUND RETRANS</li> <li>• CHECK WITH S3 ON CHANGES TO PLAN</li> <li>• CHECK WITH CHEMO-IS RETRANS LOCATION ON HIS TERRAIN MANAGEMENT BOARD</li> <li>• WHAT ATTACHMENTS HAVE BEEN ADDED THAT TALK ON BDE NETS-RESERVE COMPANY, ADA OPS ETC. HOW WILL THEY TALK, WE BRIEF THEM ON: SOI, ANTIJAM, SECURE (CAN BE DONE AT REHEARSAL SITE, MAIN CP)</li> </ul>

Figure A-3. Communications planning process guide,

SIGNAL ANNEX					
OPORD 00-00	PREP RECON-CRECON	OBJ PERRARI	OBJ PORSHE	OBJ VOLKSWAGON	REORG RECONST
RETRANS TM 1	RETRANS REGT CMD NK 278142	NO CHANGE	→	→	REORG RECONST REDEPLOY
RETRANS TM 2	RETRANS RCAT AT NK 258158	NO CHANGE		→	↓
NODE CENTER 10	NK 183186	NO CHANGE	→	→	
NODE CENTER 11	NK 335005	% NK 275959	NO CHANGE	→	
REMOTE RAU 14	IN RESERVE AT NC 10	NO CHANGE	→	→	
RTAC	NK 180274	% NK 257215	NK 364153	NO CHANGE	REORG RECONST REDEPLOY
		% NK 364153			
RTOC	NK 180274	NO CHANGE	% NK 305156	NO CHANGE	REORG RECONST REDEPLOY
COORDINATING INSTRUCTIONS: RETRANS RFSE NET, BEGINNING PHASE 2 1/3 AND 2/3 WILL FORM RETRANS TEAMS TO SPT CAT MISSION REGT RETRANS TM 1 WILL BACK UP 1/3 OR 2/3 AS REQUIRED.					
SOC: 2/3, 1/3, 4/3, SPT/3			SIGN: WARDEN C/SIGN: MOTION		
ANTLIAM PLAN					
RADIO NET	FREQUENCY	ALT FREQ 1	ALT FREQ 2	ALT FREQ 3	
COMMAND	CMD	SPARE 3	SPARE 7		
OPS/INTEL	O / I	SPARE 4	SPARE 8		
FIRE SUPPORT	FSE	SPARE 5	SPARE 9		
ADMIN/LOG	AL	SPARE 6	SPARE 10		
SOI INDEX NUMBER: EDITION "B" IN EFFECT					

Figure A-4. Signal annex/matrix.

SIGNAL ANNEX/MATRIX					
FRAGO 00-00	Recon/C-Recon	MTC	Trans. Future	Defense	
RETRANS TMS 1 AND 2	In Reserve at RTAC % Provide Retrans CMD, O/I		NO CHANGE	→	
NODE CENTER 10	NK 621177		NO CHANGE	→	
NODE CENTER 11	NK 335005		NO CHANGE	→	
REMOTE RAJ 10	NK 573107		NO CHANGE	→	
REMOTE RAJ 11 RELAY Z11	NJ 575025		NO CHANGE	→	
FTOC	NK 548156	% Survival NK 548164	NO CHANGE	→	
RTAC	NK 534083	LD 0600 NK 508093	NO CHANGE	→	
COORDINATING INSTRUCTIONS: REGT RETRANS PRIORITY TO 2/3 ACR TO SUPPORT C2 OF ECONOMY OF FORCE. SOI CHANGE AT 1700(L) FAST BREAK WILL OCCUR 1 HOUR PRIOR TO LD.					
SOC: 2/3, 4/3, SPT/3			SIGN: WARDEN C/SIGN: KINGPIN		
ANTIJAM PLAN					
RADIO NET	FREQUENCY	ALT FREQ 1	ALT FREQ 2	ALT FREQ 3	
COMMAND	CMD	SPARE 3	SPARE 7		
OPS/INTEL	O/I	SPARE 4	SPARE 8		
FIRE SUPPORT	FSE	SPARE 5	SPARE 9		
ADMIN/LOG	A/L	SPARE 6	SPARE 10		
SOI INDEX NUMBER: EDITION "A" IN EFFECT					

Figure A-4. Signal annex/matrix (cont).

**ANNEX K, Signal, to 19TH BDE  
FRAGO 00-00-00**

**1. SITUATION:**

a. Enemy: SEE CURRENT INTSUM

b. Friendly: SEE BASIC FRAGO

2. MISSION: COM COMMUNICATIONS IN SUPPORT OF 19TH BDE TASK  
FORCE OPERATIONS TO SEIZE OBJECTIVES JALIBAH (RED) AND TALLI  
(GREEN)

**3. EXECUTION:**

a. Concept of Operations: RETRANS AND RELAY TEAMS WILL PROVIDE PRIMARY, 2<sup>ND</sup>  
AND REDUNDANCY FOR THE BDE CMD NET AND THE FIRE SUPPORT NET.

**b. Mission of Subordinate Units:**

(1) CDR TF 0-00, OPCON IEA RETRANS TEAM WITH VEHICULAR RETRANS SYSTEM AND  
WITH GPS TO BDE SIGNAL OFFICER NLT 161200 APR 94.

(2) CDR TF 0-15, OPCON IEA RETRANS TEAM WITH VEHICULAR RETRANS SYSTEM AND  
WITH GPS TO BDE SIGNAL OFFICER NLT 161200 APR 94.

(3) CDR 0-41, a.) OPCON IEA RETRANS TEAM WITH VEHICULAR RETRANS SYSTEM AND  
WITH GPS TO BDE SIGNAL OFFICER NLT 161200 APR 94. b.) OPCON ZEA TWO MAN TEAMS,  
EACH WITH MPR COMPLETE WITH SINGARS TO THE BDE SIGNAL OFFICER NLT 01200.

(4) CDR HHC 19 BDE, OPCON BDE CDR'S DRIVER WITH VEHICLE AND THE SS'S DRIVER WITH  
VEHICLE TO THE BDE SIGNAL OFFICER NLT 161200 APR 94.

**c. Coordinating Instructions:**

(1) CALL SIGNS, FREQUENCIES, PASSWORD AND CHALLENGES CHANGE AT 1700 HOURS  
(LOCAL) DAILY.

(2) ANTILAM PLAN - NO CHANGE.

4. SERVICE AND SUPPORT: SEE LOGISTICS ANNEX

**5. COMMAND & SIGNAL:****a. Command:**

NTC 501 00-00, EDITION B IN EFFECT:

**b. Signal:**

(1) PHASE I MAIN: NK 197218, TAG: NK 198216

(2) PHASE II MAIN: NK 197218, TAG: NK 351086 RETRANS: NK 275086

(3) PHASE III MAIN: NK 429197, TAG: NK 504093 RETRANS: NK 443118

(4) PHASE IV MAIN: NK 429197, TAG: NK 504093 RETRANS: NK 443118

*Figure A-5. Annex K, fragmentary order (FRAGO).*

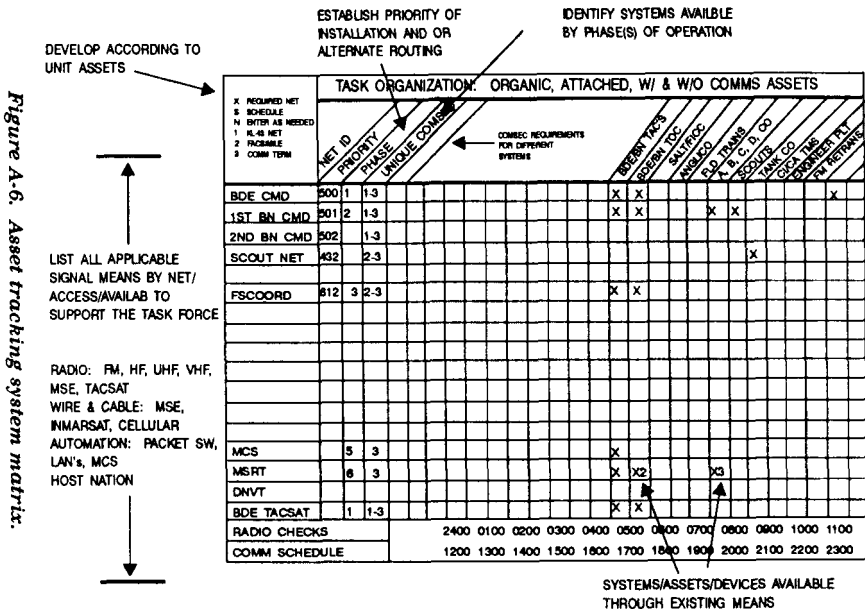

System	FA Bn			AVN Bn			BSA			SEP Co		
	Auth	O/H	NMC	Auth	O/H	NMC	Auth	O/H	NMC	Auth	O/H	NMC
BC TACSAT												
(HPR)												
PRC-183												
PRC-213												
PRC-104												
(SINGAPORE)												
VRC-92												
VRC-89												
VRC-90												
PRC-119												
(Handheld)												
PRC-126												
(MSE)												
MSRT												
DNVT												
FAX												
RAU												
SEN												
NPI												
AM Radios												
Remarks	As of: _____						Reserves					

Figure A-7. Communications status.

COMMAND AND SIGNAL					
COMMAND:					
COMMAND ELEMENT	LOCATION	ALT LOCATION	EVENT THAT WILL CAUSE DISPLACEMENT		OIC
CMD GROUP					
SUCCESSION OF CMD			SPECIAL:		
Signal:					
AntiJam Plan					
Event	Radio Net	Frequency	Alt Freq 1	Alt Freq 2	Alt Freq 3
SOI INDEX NUMBER:			DTG:		

Figure A-8. Communications status worksheet.



<u>Vehicle/Generators</u>	<u>Mission Brief</u>
<input type="checkbox"/> PMCS <input type="checkbox"/> Fuel <input type="checkbox"/> Camouflage Nets <input type="checkbox"/> Load Plan Checked/Verified	<input type="checkbox"/> Map/Graphics <input type="checkbox"/> Enemy/Friendly situation <input type="checkbox"/> Mission <input type="checkbox"/> Route <input type="checkbox"/> Operational Time <input type="checkbox"/> Medical Support <input type="checkbox"/> Decon Link Up Points <input type="checkbox"/> Resupply <input type="checkbox"/> Destruction Procedures <input type="checkbox"/> Recall Procedures
<u>C&amp;E</u>	
<input type="checkbox"/> Radio Check w/PRM-34 <input type="checkbox"/> OE-254/RC-292 Complete <input type="checkbox"/> Radio Retrans Both Ways	
<u>Personnel</u>	<u>Fregs</u>
<input type="checkbox"/> Food/Water <input type="checkbox"/> Weapons: <ul style="list-style-type: none"> <li><input type="checkbox"/> Cleaned</li> <li><input type="checkbox"/> Ammo</li> <li><input type="checkbox"/> Test Fired/Zeroed</li> </ul>	<input type="checkbox"/> Antijam Plan <input type="checkbox"/> All Fregs Tested <input type="checkbox"/> COMSEC
<u>NBC:</u>	
<input type="checkbox"/> Complete/Serviceable Suit <input type="checkbox"/> Injectors and M258 Kits <input type="checkbox"/> Extra Suits <input type="checkbox"/> Pretreatment Pills <input type="checkbox"/> M256 Kit <input type="checkbox"/> M8/9 Paper	

**Figure A-9. Retransmission team checklist.**

## Appendix B

# MSE Distribution

*Table B-1. Corps MSE signal brigade equipment chart.*

	CORPS SIGNAL BRIGADE														TOTAL BDE
	NC	HHC	CORPS AREA SIGNAL BN						HHC	CORPS SPT SIGNAL BN				TOTAL BN	
			AREA SIG CO			SPT CO	TOTAL BN	AREA SIG CO		SPT CO		TOTAL BN			
			A	B	C					A	B				
LOS V1	5		10	10	10	17	47		10	10	8	28	169		
LOS V2						1	1				1	1	4		
LOS V3	4		8	8	8		24		8	8		16	88		
LOS V4						1	1				1	1	4		
NC	1		2	2	2		6		2	2		4	22		
LEN						1	1				1	1	4		
RAU	2		4	4	4	1	13		4	4		8	47		
SEN (V1)	3		6	6	6	12	30		6	6	6	18	108		
SEN (V2)	1		2	2	2	4	10		2	2	2	6	36		
NMF	1		2	2	2	1	7		2	2	1	5	26		
SCC		2											2		
NA							2	2				2	8		
NFI	2		2	2	2	1									

# Appendix B

## MSE Distribution

*Table B-1. Corps MSE signal brigade equipment chart.*

CORPS SIGNAL BRIGADE													
	NC	HHC	CORPS AREA SIGNAL BN					CORPS SPT SIGNAL BN					TOTAL BDE
			AREA SIG CO			SPT CO	TOTAL BN	HHC	AREA SIG CO		SPT CO	TOTAL BN	
			A	B	C				A	B			
LOS V1	5		10	10	10	17	47		10	10	8	28	169
LOS V2						1	1				1	1	4
LOS V3	4		8	8	8		24		8	8		16	88
LOS V4						1	1				1	1	4
NC	1		2	2	2		6		2	2		4	22
LEN						1	1				1	1	4
RAU	2		4	4	4	1	13		4	4		8	47
SEN ( V1)	3		6	6	6	12	30		6	6	6	18	108
SEN ( V2)	1		2	2	2	4	10		2	2	2	6	36
NMF	1		2	2	2	1	7		2	2	1	5	26
SCC		2											2
NAI						2	2				2	2	8
NRI	2		2	2	2	1							

Table B-2. Heavy division MSE signal battalion equipment charts.

	5 DIV BN	1 CORPS BDE	TOTAL
LOS (V1)	156	169	325
LOS (V2)		4	4
LOS (V3)	120	88	208
LOS (V4)	5	4	9
NC	30	22	52
LEN	5	4	9
RAU	65	47	112
SEN (V1)	90	106	196
SEN (V2)	30	36	66
NMF	35	26	61
SCC	5	2	7
NAI	5	8	13

	NC	HHC	DIVISION SIGNAL BN				BN TOTAL
			AREA A	SIG B	CO C	SIG SPT CO	
LOS (V1)	5		10	10	10	1	31
LOS (V2)							
LOS (V3)	1		8	8	8		24
LOS (V4)						1	1
NC	1		2	2	2		6
LEN						1	1
RAU	2		4	4	4	1	13
SEN (V1)	3		6	6	6		18
SEN (V2)	1		2	2	2		6
NMF	1		2	2	2	1	7
SCC		1					1
NAI						1	1
NRI	2		2	2	2	1	7

## Appendix C

### Priorities of Work Chart

<b>PRIORITIES OF WORK</b>	
<ul style="list-style-type: none"> <li>● Establish security (LP/OP)</li> <li>● Position key weapons</li> <li>● Assign sectors of fire</li> <li>● Position other company assets</li> <li>● Establish comm</li> <li>● Assign fighting positions</li> <li>● Establish TRPs and other fire control measures</li> <li>● Designate FPLs and FPFs</li> <li>● Clear fields of fire</li> <li>● Prepare range cards</li> <li>● Emplace sector stakes</li> <li>● Coordinate with adjacent units</li> <li>● Prepare fighting positions/improve with overhead cover</li> <li>● Camouflage positions</li> </ul>	<ul style="list-style-type: none"> <li>● Emplace obstacles and mines</li> <li>● Dig in all comm wire</li> <li>● Conduct weapons and vehicle maintenance</li> <li>● Establish comm</li> <li>● Erect TOC tentage</li> <li>● Setup staff work area</li> <li>● Erect brief/planning tent</li> <li>● Camouflage vehicles/equip</li> <li>● Prepare TOC individual fighting positions</li> <li>● Emplace TOC access wire/entry</li> <li>● Disseminate hasty displacement plan</li> <li>● Establish casualty evacuation plan</li> <li>● Rehearse</li> </ul>

*Figure C-1. Priorities of work.*

## Appendix D Risk Assessment Chart

*Table D-1. Risk assessment chart.*

<b>LENGTH VS NATURE OF OPERATIONS</b>			
<b>LENGTH</b>	<b>ROUTINE</b>	<b>COMPLEX LT/HY/ABN</b>	<b>DANGEROUS LIVE FIRE WATER/MALO</b>
72 HOURS	3	4	5
48 HOURS	2	3	5
24 HOURS	1	2	4
<b>UNIT EXPERIENCE - NATURE OF TASK</b>			
<b>TASK</b>	<b>UNIT EXPERIENCE</b>		
	<b>QUALIFIED &amp; EXPERIENCED</b>	<b>FAMILIAR BUT NOT EXPERIENCED</b>	<b>UNFAMILIAR OR UNTRAINED</b>
DANGEROUS	2	4	5
COMPLEX	1	3	4
ROUTINE	0	2	3
<b>TEMPERATURE VS CONDITIONS</b>			
<b>TEMPERATURE</b>	<b>UNIT EXPERIENCE</b>		
	<b>GOOD CLEAR/DRY</b>	<b>DEGRADED NIGHT OR HAZE/DRIZZLE</b>	<b>POOR NIGHT, RAIN/ SNOW/ICE</b>
VERY COLD	3	4	5
MODERATE	0	2	3
VERY HOT	4	2	3
<b>EQUIPMENT AGE VS CONDITIONS</b>			
<b>AGE</b>	<b>WELL MAINTAINED</b>	<b>POORLY MAINTAINED</b>	<b>SHORT KEY EQUIPMENT</b>
OLD	2	4	4
AVERAGE	1	3	4
NEW	0	2	4

Table D-1. Risk assessment chart (cont).

<b>C2 RELATIONSHIP VS MISSION</b>			
UNIT CONFIGURATION	LEADER'S TIME FOR MISSION PREP		
	DAY	NIGHT	SPECIAL HAZARD
AD HOC	2	3	4
ATTACHED	1	2	3
ELEMENT	0	1	2
ORGANIC			
<b>LEADER'S REST VS PREP TIME</b>			
LEADER'S REST	TIME FOR MISSION PREP		
	EXTENSIVE	ADEQUATE	MINIMAL
LESS 4 HOURS	2	3	4
6 HOURS	1	2	3
8 HOURS	0	1	2
<b>SOLDIER CONDITION VS TERRAIN</b>			
TERRAIN	LENGTH OF REST		
	GOOD	ADEQUATE	MINIMAL
	8 HOURS	6 HOURS	LESS 4 HOURS
DANGEROUS	2	3	5
CHALLENGING	1	2	4
NORMAL	0	1	3
<b>RISK ASSESSMENT</b>			
LOW	MODERATE	HIGH	
1-11	12-23	24-31	
WHAT ARE YOUR RISK REDUCTION ACTIONS?			

## Glossary

# Acronyms and Abbreviations

@	at
0	degree/degrees
#	number
AC	alternating current
ACSO	assistant corps signal officer
ACUS	Area Common-User System
ADA	air defense artillery
ADDS	Army Data Distribution System
adj	adjacent
admin	administrative
ADSO	assistant division signal office/officer
AFSAT	Air Force satellite
A/L	administrative/logistics
ALICE	all-purpose lightweight individual carrying equipment
ALO	air liaison officer
ALOC	area logistics operation center
alt	alternate
AM	amplitude modulated
ANGLICO	air and naval gunfire liaison company
ant	antenna
ARLNO	Armor Liaison Officer
ARTEP	Army Training and Evaluation Program
ATCCS	Army Tactical Command and Control System
atch	attached
attn	attention



## FM 11-43

auth	authority
aux	auxiliary
avn	aviation
BAS	Battlefield Automated Systems
BATCON	battalion command
bde	brigade
BFA	Battlefield Functional Area
BIS	Battlefield Information Services
BL	baseline
blk	block(s)
BMO	battalion maintenance officer
bn	battalion
bnd	band
BOS	Battlefield Operating System
bps	bits per second
BSA	brigade support area
BSBN	baseband
BSO	brigade/battalion signal officer
btry	battery
C	clear
C <sup>2</sup>	command and control
C <sup>3</sup>	command, control, and communications
C <sup>4</sup>	command, control, communications, and computers
C <sup>4</sup> I	command, control, communications, computers and information
cbt	combat
CCES	contingency communications extension switch
CCP	contingency communications package
CCPS	contingency communications parent switch

## Glossary-2

cdr	commander
cen	center
CGSC	Command and General Staff College
chan	channel
CHEMO	chemical officer
CHS	common hardware and software
CM	control monitor
cmd	command
CNR	combat net radio
CNV	crypto net variable
co	company
CO	commercial
COA	course of action
coax	coaxial cable
COMCAM	combat camera
comm	communications
COMSEC	communications security
CONUS	continental United States
COSCOM	corps support command
CP	command post
CS	combat support
CSCE	communications system control element
CSS	combat service support
CT	communications terminal
CTA	common table of allowances
D	depth
DA	Department of the Army
DC	direct current
DCNRI	dismounted combat net radio interface
DCS	Defense Communications System
DDN	defense data network

## FM 11-43

DES	dismounted extension switch
DGM	digital group multiplexing
dig	digital
dir	directory
DISCOM	division support command
DISN	Defense Information Systems Network
div	division
DIVARTY	division artillery
DLOS	dismounted line-of-sight
DMAIN	division main
DNMF	dismounted node management facility
DNI	digital NATO interface
DNVT	digital nonsecure voice terminal
doc	documentation
DOD	Department of Defense
DOIM	Directorate of Information Management
DOS	disk operating system
DSN	defense switching network
DSVT	digital subscriber voice terminal
DTG	digital transmission group
DTOC	division tactical operations center
DVOW	digital voice orderwire
ea	each
EA	electronic attack
EAC	echelons above corps
ECM	electronic countermeasures
ECB	echelons corps and below
ECCM	electronic counter countermeasures
EMP	electromagnetic pulse
enr	engineer
ENT	enter

## Glossary-4

EOW	engineering orderwire
EPLRS	Enhanced Position Location Reporting System
equip	equipment
ERF	electronic remote fill
F	fahrenheit
FA	field artillery
fctn	function
FES	force entry switch
FH	frequency hopping
FLOT	forward line of own troops
FLTSAT	fleet satellite
FM	frequency modulated/field manual when used with a number
FOIA	Freedom of Information Act
FPF	final protective fire
FPL	final protective line
FRAGO	fragmentary order
freq	frequency
FSC	fire support coordinator
FSE	fire support element
FSO	fire support officer
ft	feet
fwd	forward
G3	Assistant Chief of Staff, G3 (Operations and Plans)
G6	signal officer/office
gal	gallon(s)
gen	generator(s)
GFE	Government Furnished Equipment

## FM 11-43

GHz	gigahertz
GM	group modem
GTA	graphic training aid
H	height
HAEMP	high altitude electromagnetic pulse
HF	high frequency
HHC	headquarters and headquarters company
HI	high
HMMWV	high mobility multipurpose vehicle
HPT	high priority target
HQ	headquarters
HVA	high voltage assembly
HVT	high value target
Hz	hertz
ICOM	integrated COMSEC
IHFR	Improved High Frequency Radio
IGW	Integral Gateway
IMA	Information Mission Area
intel	intelligence
IP	Internet Protocol
IPB	intelligence preparation of the battlefield
ISSO	Information Services Support Office
ISYSCON	integrated system control
JCCC	Joint Command and Control Center
JCCT	Joint Command and Control Tactical Operations Center
JTIDS	Joint Tactical Information Distribution System
kbps	kilobits per second
KEK	key encryption key
km	kilometer(s)

## Glossary-6

Km/h	kilometers per hour
kw	kilowatt
L	length
LAN	local area network
LAW	light antitank weapon
lbs	pounds
LCCES	light contingency communications extension switch
LCCP	light contingency communications package
LCCPS	light contingency communications parent switch
LD	load
LDF	lightweight digital facsimile
ldr	leader
LED	light emitting diode
LEN	large extension node
LF	low frequency
LO	low
log	logistics
LOS	line-of-sight
LP	listening point
LSB	lower sideband
LTU	line termination unit
m	meter(s)
man	manual
MARKS	The Modern Army Recordkeeping System
max	maximum
M/C	multichannel
MCS	Maneuver Control System
MDTG	multiplex digital transmission group
METT-T	mission, enemy, terrain, troops, and time

## FM 11-43

MF	medium frequency
mgt	management
MHz	megahertz
MI	Military Intelligence
min	minute(s)
MMC	Materiel Management Center
MP	Military Police
MPH	miles per hour
MSE	Mobile Subscriber Equipment
MSRT	mobile subscriber radiotelephone terminal
mux	multiplex
mvr	maneuver
NAI	NATO analog interface
NATO	North Atlantic Treaty Organization
NBC	nuclear, biological, chemical
NC	node center
NCO	noncommissioned officer
NCS	net control station
NMF	node management facility
non-ICOM	non-integrated COMSEC
NRI	net radio interface
NSN	national stock number
NVIS	near vertical incidence sky wave
OCONUS	outside continental United States
OIC	officer in charge (of)
OOTW	operations other than war
OP	operations post
OPCON	operational control
OPLAN	operation plan
OPORD	operation order
ops	operations

## Glossary-8

PA	Privacy Act/power amplifier when used in radio configurations
para	paragraph
PAC	Personnel and Administrative Center
PC	personal computer
PIR	personnel information roster
PLL	prescribed load list
plt	platoon
PMCS	Preventive Maintenance Checks and Services
PNMC	packet network management center
POS/NAV	position location/navigation
pr	pair
PSN	packet switch network
PSYOP	psychological operations
pwr	power
quan	quantity
R&S	reconnaissance and surveillance
RAU	radio access unit
RAVN	Regimental aviation
RCU	remote control unit
rcv	receive
RETRANS	retransmission
recon	reconnaissance
RF	radio frequency
RMC	remote multiplexer combiner
RP	release point
RPM	revolutions per minute
RSS-D	downsize routing subsystem
Rt	route
RT	receiver-transmitter



## FM 11-43

S1	Adjutant (US Army)
S2	Intelligence Officer (US Army)
S3	Operations and Training Officer (US Army)
S4	Supply Officer (US Army)
SB	switchboard
SCC-2	system control center-2
SCI	sensitive compartmented information
SDC	signal data connector
sec	section
SEN	small extension node
SHF	super high frequency
SICPS	Standard Integrated Command Post System
sig	signal
SIGO	signal officer
SINCGARS	Single-Channel Ground and Airborne Radio System
SITTEMPS	situation templates
SOCCE	special operations command and control element
SOCOM	special operations command
SOI	signal operation instructions
SOP	standing operating procedure
SP	start point
spt	support
SSB	single sideband
ST	student text
STANAG	Standardization Agreement
STO	store

SUBS	subscriber(s)
supv	supervisor
sw	switch
SYSCON	system control
TAACOM	Theater Army Area Command
tac	tactical
TAC CP	tactical command post
TACP	tactical air control party
TACFIRE	Tactical Fire Direction System
TACSAT	tactical satellite
TAI	targeted area of interest
TASO	terminal area security officer
tech	technical
TED	trunk encryption device
temp	temporary
TEK	trunk encryption key
TGC	trunk group cluster
thru	through
TIM	transmission interface module
TM	technical manual
TNS	tactical name server
TOC	tactical operations center
TPN	Tactical Packet Network
TRADOC	United States Army Training and Doctrine Command
TRI-TAC	Tri-Service Tactical Communications
TROPO	tropospheric scatter
TRP	target reference point
TS	TOP SECRET
TSC(A)	theater signal command (Army)
TSK	transmission security key

## FM 11-43

TTA	tactical terminal adapter
tty	teletypewriter
UAV	unmanned aerial vehicle
UHF	ultra high frequency
UPS	universal power supply
USB	upper sideband
VAC	Volts alternating current
VDC	Volts direct current
veh	vehicle
VFC	Voice frequency channel
VHF	very high frequency
VHF-FM	very high frequency-frequency modulated
VI	visual information
vs	versus
w/	with
W	watts
WAN	wide area network
XMT	transmit
XO	executive officer
XTRA	extra

## References

These documents must be available to the intended users of this publication.

### Army Regulation (AR)

AR 25-50. *Preparing and Managing Correspondence*. 21 November 1988.

AR 25-55. *The Department of the Army Freedom of Information Act Program*. 10 January 1990.

AR 340-21. *The Army Privacy Program*. 5 July 1985.

### Command and General Staff College, Student Text (ST)

ST 101-5. *The Command and Staff Decision Process*. January 1994.

### Common Table of Allowances (CTA)

CTA 50.909. *Field and Garrison Furnishings and Equipment*. 01 June 1989.

## **FM 11-43**

### **Department of the Army (DA) Form**

DA Form 2028. *Recommended Changes to Publications and Blank Forms*. February 1974.

### **Field Manual (FM)**

FM 11-32. *Combat Net Radio Operations*. 15 October 1990.

FM 11-75. *Battlefield Information Services (BIS)*. 20 September 1994.

FM 24-18. *Tactical Single-Channel Radio Communications Techniques*. 30 September 1987.

FM 22-100. *Military Leadership*. 31 July 1990.

FM 24-40. *Tactical Visual Information (FMFM 3-8)*. 12 December 1991.

FM 55-30. *Army Motor Transport Units and Operations*. October 1989.

FM 71-123. *Tactics and Techniques for Combined Arms Heavy Forces: Armored Brigade, Battalion/Task Force, and Company/Team*. 30 September 1992.

## **References-2**

## **Field Manual (FM) (cont)**

FM 90-3. *Desert Operations (FMFM 7-27)*. 24 August 1993.

FM 90-5(HTF). *Jungle Operations (How to Fight)*. 16 August 1982.

FM 90-6. *Mountain Operations*. 30 June 1980

## **Standardization Agreement (STANAG)**

STANAG 4206. *The NATO Multi-Channel Tactical Digital Gateway - System Standards*.

STANAG 4212. *The NATO Multi-Channel Tactical Digital Gateway - Radio Relay Link Standards*.

STANAG 4214. *International Routing and Directory for Tactical Communications Systems*.

STANAG 5040. *NATO Automatic and Semi-automatic Interfaces Between the National Switched Telecommunications Systems of the Combat Zone and Between These Systems and the NATO Integrated Communications System (NICS); Period 1975 to 1990s*.

## FM 11-43

### Supply Bulletin (SB)

SB 11-6. *FSC Class 6135 Primary Battery Supply and Management Data*. 01 April 1993.

### Technical Manual (TM)

TM 11-5800-216-10-4. *System Manual for Mobile Subscriber Equipment (MSE)*. November 1992.

TM 11-5820-401-10-1. *Operator's Manual for Radio Sets AN/VRC-12 (NSN 5820-00-223-7412), AN/VRC-43 (5820-00-223-7415), AN/VRC-44 (5820-00-223-7417), AN/VRC-45 (5820-00-223-7418), AN/VRC-46 (5820-00-223-7433), AN/VRC-47 (5820-00-223-7434), AN/VRC-48 (5820-00-223-7435), and AN/VRC-49 (5820-00-223-7437) (Used without Intercom Systems)*. 14 January 1986.

TM 11-5820-401-10-1-HR. *Hand Receipt Manual Covering End Item/Components of End Item (COEI), Basic Issue Items (BII), and Additional Authorization List (AAL) for Radio Sets AN/VRC-12 (NSN 5820-00-223-7412), AN/VRC-43 (5820-00-223-7415), AN/VRC-44 (5820-00-223-7417), AN/VRC-45 (5820-00-223-7418), AN/VRC-46 (5820-00-223-7433), AN/VRC-47 (5820-00-223-7434), AN/VRC-48 (5820-00-223-7435), and AN/VRC-49 (5820-00-223-7437) (used without Intercom Systems)*. 05 January 1979.

## References-4

TM 11-5820-401-10-2. *Operator's Manual for Radio Sets, AN/VRC-12 (NSN 5820-00-223-7412), AN/VRC-43 (5820-00-223-7415), AN/VRC-44 (5820-00-223-7417), AN/VRC-45 (5820-00-223-7418), AN/VRC-46 (5820-00-223-7433), AN/VRC-47 (5820-00-223-7434), AN/VRC-48 (5820-00-223-7435), and AN/VRC-49 (5820-00-223-7437) (used with an Intercom System)*. 01 September 1990.

TM 11-5820-401-10-2-HR. *Hand Receipt Manual Covering the End Item/Components of End Items (COEI), Basic Issue Items (BII), and Additional Authorization List (AAL) for Radio Sets, AN/VRC-12 (NSN 5820-00-223-7412), AN/VRC-43 (5820-00-223-7415), AN/VRC-44 (5820-00-223-7417), AN/VRC-45 (5820-00-223-7418), AN/VRC-46 (5820-00-223-7433), AN/VRC-47 (5820-00-223-7434), AN/VRC-48 (5820-00-223-7435), and AN/VRC-49 (6820-00223-7437) (used with Intercom System)*. 05 January 1979.

TM 11-5820-401-10-4. *Operator's Quick Checks for Receiver-Transmitter, RT-246( )/VRC (NSN 5820-00-892-0623) and RT-524( )/VRC (5820-00892-0622)*. 16 October 1980.

TM 11-5820-890-10-1. *Operator's Manual for SINCGARS Ground Combat Net Radio, ICOM Manpack Radio AN/PRC-119A (NSN 5820-01-267-9482) (EIC: L2Q), Short Range Vehicular Radio AN/VRC-87A (5820-01-267-9480) (EIC: L22), Short Range Vehicular Radio with Single Radio Mount AN/VRC-87C (5820-01-3042045) (EIC: GDC), Short Range*



## FM 11-43

*Vehicular Radio with Dismount AN/VRC-88A (5820-01-267-9481) (EIC: L23), Short Range Vehicular Radio with Dismount and Single Radio Mount AN/VRC-88C (5820-01-304-2044) (EIC: GDD), Short Range/Long Range Vehicular Radio AN/VRC-89A (5820-01-267-9479) (EIC: L24), Long Range Vehicular Radio AN/VRC-90A (5820-01-268-5105) (EIC: L25), Short Range/Long Range Vehicular Radio with Dismount AN/VRC-91A (5820-01-267-9478) (EIC: L26), Short Range/Long Range Vehicular Radio AN/VRC-92A (5820-01-267-9477) (EIC: L27).* 01 September 1992.

TM 11-5820-890-10-2. *SINCGARS ICOM Ground Radio Operator's Pocket Guide for Manpack Radio AN/PRC-119A (NSN 5820-01-267-9482) (EIC: L2Q), Short Range Vehicular Radio AN/VRC-87A (5820-01-267-94730) (EIC: L22), Short Range Vehicular Radio with Single Radio Mount AN/VRC-87C (5820-01-304-2045) (EIC: GDC), Short Range Vehicular Radio with Dismount AN/VRC-88A (5820-01-267-9481) (EIC: L23), Short Range Vehicular Radio with Dismount and Single Radio Mount AN/VRC-88C (5820-01-304-2044) (EIC: GDD), Short Range/Long Range Vehicular Radio AN/VRC-89A (5820-01-267-9479) (EIC: L24), Long Range Vehicular Radio AN/VRC-90A (5820-01-268-5105) (EIC: L25), Short Range/Long Range Vehicular Radio with Dismount AN/VRC-91A (5820-01-267-9478) (EIC: L26), Short Range/Long Range Vehicular Radio AN/VRC-92A (5820-01-267-9477) (EIC: L27).* 01 September 1992.

## References-6

TM 11-5820-890-10-3. *Operator's Manual for SINCGARS Ground Combat Net Radio, Non-ICOM Manpack Radio AN/PRC-119 (NSN 5820-01-151-9915) (EIC: L2A), Short Range Vehicular Radio AN/VRC-87 (5820-01-151-9916) (EIC: LT2), Short Range Vehicular Radio (with Single Radio Mount) AN/VRC-87D (5820-01-351-5259) (EIC: TBD), Short Range Vehicular Radio with Dismount AN/VRC-88 (5820-01-151-9917) (EIC: L2U), Short Range Vehicular Radio with Dismount (with Single Radio Mount) AN/VRC-88D (5820-01-352-1694) (EIC: TBD), Short Range/Long Range Vehicular Radio AN/VRC-89 (5820-01-151-9918) (EIC: L2V), Long Range Vehicular Radio AN/VRC-90 (5820-01-151-9919) (EIC: L2W), Short Range/Long Range Vehicular Radio with Dismount AN/VRC-91 (5820-01-151-9920) (EIC: L2X), Short Range/Long Range Vehicular Radio AN/VRC-92 (5820-01-151-9921) (EZC: L2Y).* 01 September 1992.

TM 11-5820-890-10-4. *SINCGARS Non-ICOM Ground Radio Operator's Pocket Guide Radio Sets, Manpack Radio (AN/PRC-119) (NSN: N/A) (EIC: N/A) Vehicular Radios (AN/VRC-87 thru AN/VRC-92) (NSN: N/A) (EIC: N/A).* 01 September 1992.

TM 11-5820-890-10-HR. *Hand Receipt Covering Contents of Components of End Item (COEI), Basic Issue Items (BII), and Additional Authorization List (AAL) for SINCGARS Non-ICOM and ICOM Radio Sets AN/PRC-119 (NSN 5820-01-151-9915), (EIC: L2A) AN/PRC-119A (5820-01-267-9482), (EIC: L2Q), AN/VRC-*

## FM 11-43

87 (5820-01-151-9916), (EIC: LT2) AN/VRC-87A (5820-01-267-9480), (EIC: L22) AN/VRC-87C (5820-01-304-2045), (EIC: GDC) AN/VRC-87D (5820-01-351-5259), (EIC: N/A) AN/VRC-88 (5820-01-151-9917), (EIC: L2U) AN/VRC-88A (5820-01-267-9481), (EIC: L23) AN/VRC-88C (5820-01-3042044), (EIC: GDD) AN/ VRC-88D (5820-01-352-1694), (EIC: N/A) AN/VRC-89 (5820-01-151-9918), (EIC: L2V) AN/VRC-89A (5820-01-267-9479), (EIC: L24) AN/VRC-90 (5820-01-151-9919), (EIC: L2W) AN/VRC-90A (5820-01-268-5105), (EIC: L25) AN/VRC-91 (5820-01-151-9920), (EIC: L2X) AN/VRC-91A (5820-01-267-9478), (EIC: L26) AN/VRC-92 (5820-01-151-9921), (EIC: L2Y) AN/VRC-92A (5820-01-267-9477), (EIC: L27) (with Control Receiver-Transmitter C-11561(C)/U (RCU) (5895-01-277-2680), (EIC: N/A). 01 September 1992.

TM 11-7025-267-12. *Operator's and Unit Maintenance Manual for Terminal, Communications AN/UGC-144*. 01 August 1992.

## Training Circular (TC)

TC 24-21. *Tactical Multichannel Radio Communications Techniques*. 03 October 1988.

## References-8

**United States Army Training and Doctrine  
Command (TRADOC) Pamphlet**

TRADOC Pam 11-9. *Blueprint of the Battlefield*. July  
1989.

## Index

- AN/VRC-12, 3-2, 4-3--4-7, 4-15
- area common-user system (ACUS), 1-3, 1-11--1-13, 2-8, 2-10, 2-13, 2-16--2-19, 3-1--3-3, 3-10, 3-12, 3-13, 3-18, 3-63, 4-7
- area communications systems, 3-1--3-87
- army, 1-3, 1-4, 1-11--1-13,
  - data distribution system (ADDS), 1-3, 1-4, 1-11--1-13
  - tactical command and control system (ATCCS), 1-11--1-13
- automatic net control device (AN/CZY-10), 4-15
- automation, 1-1, 1-5, 1-11, 2-1, 2-3, 2-5, 2-17
  
- batteries, 3-63, 5-17, 5-22--5-24
  - dry-cell, 5-22
  - stockage chart, 5-24
  - wet-cell, 3-63, 5-17, 5-22, 5-23
- battlefield,
  - automated systems (BAS), 1-5
  - functional areas (BFA), 1-11, 1-12
  - information services (BIS), 1-11, 1-14, 1-15, 2-3, 2-5, 2-7
  - operating systems (BOS), 1-11, 1-12, A-1--A-4
- brigade/battalion signal officer (BSO), 2-10--2-16, 2-21, 2-23, 3-12, 3-19, A-5
- broadcast communications system, 1-2--1-4, 1-12, 1-13

## FM 11-43

- cold weather operations, 5-16, 5-17
- combat, 1-3, 1-4, 1-6--1-9, 1-11--1-13, 2-9, 2-12--2-16, 2-21, 2-24, 3-13, 3-32, 3-50, 3-51, 3-59, 3-78, 4-1--4-24
  - camera (COMCAM), 1-6--1-9
  - net radio (CNR), 1-3, 1-4, 1-11--1-13, 2-13--2-16, 2-24, 3-13, 3-32, 3-50, 3-51, 3-59, 3-78, 4-1--4-24
  - service support, 2-12, 4-7
  - support, 2-9, 2-12, 4-7
- command,
  - and control (C<sup>2</sup>), 1-1, 1-4, 1-11, 2-14, 4-3, 4-20
  - post (CP), 2-13, 2-17, 2-19--2-24, 3-12, 3-45, 3-63, 5-13
    - planning, 2-20--2-23,
- communications, 1-1--1-4, 1-11--1-13, 2-1, 2-3--2-8, 2-10--2-14, 2-16, 2-19, 2-22--2-24, 3-1, 3-2, 3-4, 3-25--3-28, 3-31, 3-32, 3-35--3-37, 3-39, 3-51, 3-52, 3-55--3-57, 3-59, 3-61, 3-63, 3-65, 3-66, 3-79, 3-85, 3-87, 4-1--4-3, 4-7, 4-19--4-22, 4-24, 5-5, 5-6, 5-10, 5-14, 5-16--5-21, A-1--A-17
  - architecture, 1-13
  - broadcast, 1-2--1-4, 1-12, 1-13
  - common user, 1-3
  - maneuver brigade/battalion, 2-13, 2-14
  - planning guide 2-10, A-1--A-17
  - sole user, 1-3
  - tactical, 1-2, 1-3, 1-12, 2-19, 4-2
  - terminal(CT), AN/UGC-144, 2-19, 3-63, 3-85--3-87
  - under special conditions, 5-16--5-22
    - cold weather, 5-16, 5-17
    - desert, 5-17, 5-18
    - jungle, 5-18, 5-19
    - mountain, 5-19, 5-20

- nuclear environment, 5-21, 5-22
- urban, 5-20, 5-21
- voice, 1-2, 1-3, 1-12, 2-13, 3-1, 3-2, 3-6, 3-31, 3-45, 3-48, 3-55, 3-63, 3-65, 3-66, 4-2, 4-3, 4-7, 4-10, 4-19, 4-21, 4-22
- contingency communications, 2-8, 2-9, 2-20, 3-15, 3-25--3-40
  - extension switch (CCES), 3-32, 3-34, 3-35
  - package (CCP), 2-8, 2-9, 2-20, 3-15, 3-25--3-37, 3-40
  - parent switch (CCPS), 3-25, 3-31, 3-32, 3-33, 3-35, 3-39, 3-40
- convoy, 5-3--5-13
  - commander's brief, 5-7--5-9
  - conducting operations, 5-3--5-10
  - organization, 5-3, 5-4
  - planning factors, 5-4, 5-5
- corps, 2-1--2-4,
  - area signal battalion, 2-4
  - signal brigade, 2-1--2-3
  - signal brigade staff, 2-3
  - signal office, 2-2
  - signal support, 2-1
  - support signal battalion, 2-4
  - supporting the, 2-1--2-9
- desert operations, 5-17, 5-18
- digital nonsecure voice terminal (DNVT), 3-6, 3-50, 3-63--3-66, 3-84, 3-85
- digital subscriber voice terminal (DSVT), 3-31, 3-63--3-66, 3-71--3-77, 3-84, 3-85
  - affiliation procedures, 3-72-3-77

## FM 11-43

- dismounted extension switch (DES), 3-25, 3-32, 3-35
- dismounted LOS (DLOS), 3-25, 3-32
- dismountable NMF (DNMF), 3-31
- division, 1-14, 2-5--2-7, 2-13, 2-17
  - signal battalion, 2-5--2-7, 2-13, 2-17
  - signal battalion elements, 2-5, 2-6
  - signal battalion staff, 2-5, 2-7
  - signal office, 1-14, 2-5, 2-6
  
- enhanced position location reporting system (EPLRS), 1-4, 2-8
  
- facsimile operation, 3-84, 3-85
  
- improved high frequency radio (IHFR), 4-2, 4-3, 4-19--4-24
- information mission area (IMA), 1-1, 1-11--1-14,
  
- joint tactical information distribution system (JTIDS), 1-4
- jungle operations, 5-18, 5-19
  
- large extension node (LEN), 2-4, 2-8, 2-20, 3-1, 3-6, 3-10--3-12, 3-15, 3-21, 3-25, 3-35, 3-41, 3-43, 3-45, 3-49, 3-51, 3-57, 3-59, 3-61, 4-7
- light contingency communications, 2-8, 2-20, 3-35--3-40
  - package (LCCP), 2-8, 2-20, 3-35--3-40
  - extension switch (LCCES), 3-35
  - parent switch (LCCPS), 3-39, 3-40
- lightweight digital facsimile (LDF), AN/UXC-7/7A, 3-63, 3-78, 3-79, 3-80, 3-81, 3-82, 3-83, 3-84
- line-of-sight (LOS), 1-3, 2-22, 3-6, 3-10, 3-12, 3-15--3-18, 3-25, 3-31, 3-32, 3-35, 3-41, 3-50, 3-51, 3-53, 3-55, 3-61,

## Index-4



- 4-2, 5-1--5-3, 5-10, 5-11, 5-19, 5-20
- radio links, 3-15--3-17, 3-50
- local area network (LAN), 2-17, 2-19, 3-47, 3-49
- maneuver, 2-9--2-23,
  - battalion, 2-9-- 2-23
  - brigade, 2-9--2-23
  - brigade/battalion
    - ACUS, 2-16--2-18
    - cable and wire, 2-19
    - communications, 2-13, 2-14
    - combat net radio (CNR), 2-14, 2-15, 2-16
    - message traffic capabilities, 2-19
    - data distribution capabilities, 2-19
- mobile subscriber equipment (MSE), 1-3, 2-1, 2-4, 2-5, 2-8, 2-16, 2-17, 2-20, 3-1--3-55, 3-59, 3-63, 3-66, 3-69, 3-70, 3-78, 3-82, 3-85, 3-87, 5-2, B-1, B-2
  - local area network (LAN) troubleshooting, 3-49
  - loop back tests, 3-51--3-54
  - radiotelephone terminal (MSRT), 3-19, 3-50, 3-63, 3-65--3-74, 3-76, 3-77, A-4
    - affiliation procedures, 3-72--3-77
  - standard database, 3-41--3-44
  - tactical packet network (TPN), 3-45--3-48
  - troubleshooting, 3-50
- multiplex digital transmission group (MDTG) loop back tests, 3-51--3-54
- mountain operations, 5-19, 5-20
- near vertical incidence sky wave (NVIS), 4-20, 4-22
- net radio interface (NRI), 2-8, 2-17, 2-18, 3-13, 3-32, 3-59,

## FM 11-43

- 4-3, 4-7
- node center (NC), 2-1, 2-20, 3-6, 3-7, 3-8, 3-10, 3-12, 3-15, 3-18, 3-21, 3-25, 3-31, 3-32, 3-35, 3-41, 3-42, 3-45, 3-47, 3-50, 3-51, 3-54, 3-57, 3-59, 3-61, 3-71, 3-75, 4-7, 4-16, 4-17, 5-10
- node management facility (NMF), 3-6--3-10, 3-25, 3-31, 3-35, 3-50, 5-10
- nuclear environment, 5-21, 5-22
- power sources, 3-63, 5-17, 5-22--5-26
  - batteries, 3-63, 5-17, 5-22--5-24
  - commercial power, 5-25
  - engine-driven, 5-25
  - start-up checklist, 5-26
- printing and publications, 1-1, 1-10, 1-14
- priorities of work, C-1
- radio access unit (RAU), 2-12, 2-17, 3-6, 3-10, 3-15, 3-18--3-21, 3-25, 3-30, 3-32, 3-33, 3-35, 3-39, 3-40, 3-51, 3-59, 3-70, 4-2, 5-10
- radio links, 5-1--5-3
  - profiling, 5-1--5-3
- records management, 1-1, 1-9, 1-10, 1-14
- risk assessment 5-8, 5-13, A-3, D-1, D-2
- signal, 1-1--1-15, 2-1--2-23, 5-10--5-15,
  - brigade elements, 2-2
  - responsibilities, 1-11
  - site selection/set up, 5-10--5-12
    - defense tasks, 5-13--5-15
  - subordinate battalions, 2-2, 2-4

## Index-6

- subordinate companies, 2-5, 2-8
- support, 1-1--1-15, 2-1, 2-5, 2-8, 2-10, 2-11, 2-13
  - and organization 2-1
  - company, 2-8
  - disciplines, 1-1--1-11
  - typical sites, 5-12, 5-13
- single-channel, 1-4, 2-16, 2-17, 2-18, 3-32, 4-1, 4-2, 4-3, 4-7, 4-24
  - ground and airborne radio system (SINCGARS), 1-4, 2-17, 2-19, 2-24, 4-3, 4-7--4-23
    - electronic remote fill (ERF), 4-18, 4-19
    - FH data fill, 4-16, 4-17
    - secure device K7-57, 4-15, 4-16
  - radios, 2-13, 2-15, 2-16, 2-18, 3-32, 4-2, 4-3
  - TACSAT system, 3-13, 4-24
- small extension node (SEN), 2-17, 2-20, 2-24, 3-1, 3-10, 3-12--3-15, 3-25, 3-32, 3-35, 3-45, 3-47, 3-49, 3-51, 3-59, 3-63, 3-64, 4-7
- standard integrated command post system (SICPS), 3-8, 3-10, 3-23
- subscriber terminal equipment, 2-19, 3-63--3-87
  - CT, AN/UGC-144, 3-85--3-87
  - DNVT, TA-1035/U or TA-1042A/U, 3-63, 3-64
  - DSVT, TSEC/KY-88, 3-65, 3-66
    - affiliation procedures, 3-72--3-77
  - MSRT, AN/VRC-97, 3-66--3-77
    - affiliation procedures, 3-72--3-77
  - LDF, AN/UXC-7/7A, 3-78--3-83
- system control center-2 (SCC-2), 3-6, 3-10, 3-21, 3-22, 3-23, 3-24, 3-25, 3-45, 3-50

## **FM 11-43**

- tactical packet network (TPN), 2-17, 2-20, 3-4, 3-45, 3-46, 3-47, 3-48
- tactical satellite (TACSAT), 1-3, 2-7, 2-8, 3-6, 3-10, 3-13, 3-32, 3-55, 3-57, 4-2, 4-3, 4-24
- Tri-service tactical communications (TRI-TAC), 1-3, 2-4, 3-55--3-63
  - area node, 3-55, 3-57, 3-58, 3-59
  - extension node, 2-4, 3-59, 3-60, 3-61, 3-62, 5-13
  - medium extension node, 3-61, 3-62
  - area communications system, 3-56
  
- urban operations, 5-20
  
- visual information (VI), 1-1, 1-6, 1-7, 1-9, 1-11, 2-5, 5-22
  
- wide area network (WAN), 1-3

☆ U.S. PRINTING OFFICE : 1996 0 - 406-421 (60235)

## **Index-8**

FM 11-43  
12 JUNE 1995

By Order of the Secretary of the Army:

**GORDON R. SULLIVAN**  
*General, United States Army*  
*Chief of Staff*

**Official:**



JOEL B. HUDSON

*Acting Administrative Assistant to the*  
*Secretary of the Army*

00159

**DISTRIBUTION:**

Active Army, USAR and ARNG: To be distributed in accordance with DA Form 12-11-E, requirements for FM 11-43, *The Signal Leader's Guide*, (Qty rqr block no. 5070).